

# Einführung in die Erweiterte Realität

## 5. Head-Mounted Displays

Prof. Gudrun Klinker, Ph.D.

Institut für Informatik, Technische Universität München

[klinker@in.tum.de](mailto:klinker@in.tum.de)

Nov 30, 2004

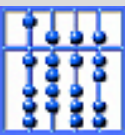

# Agenda

1. Technological issues
2. Human perception
3. Other displays for AR

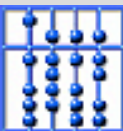

# Literature

- “Optical versus Video See-Through Head-Mounted Displays”, J.P Rolland and H. Fuchs, in *Fundamentals of Wearable Computers and Augmented Reality* (chap. 4), 2001, pp.113-156
- “Präsenz und Raumwahrnehmung in virtuellen Umgebungen”, Jan Hofmann, Doktorarbeit am Lehrstuhl für Ergonomie, Maschinenwesen, TU München, 2001.
- “SHEEP: The Shared Environment Entertainment Pasture”, C. Sandor et al, *Proc. of ISMAR 2002*, Darmstadt, Germany, 2002.

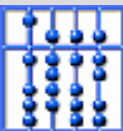

# The Human Eye

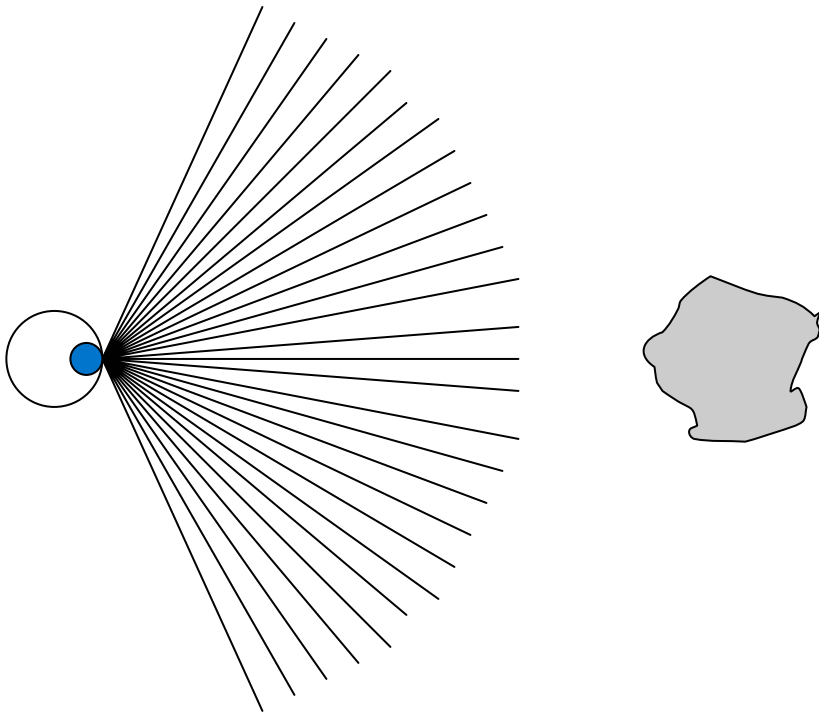

- Speed:  $> 25$  Hz ( $< 40$  ms)
- Smooth rotation: 100 deg/s
- Center of eye rotation ???
- Angular resolution:  $1/60$  deg
- Field of View:  $> 130$  deg (?)
- Depth of field:
  - (pupil 2 - 4 mm diameter)
  - at 1 m: [0.94 m .. 1.04 m]
  - at 17 m: [11 m .. 33 m]
- Distance between eyes

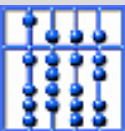

# Optical See-Through HMD

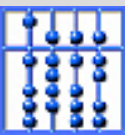
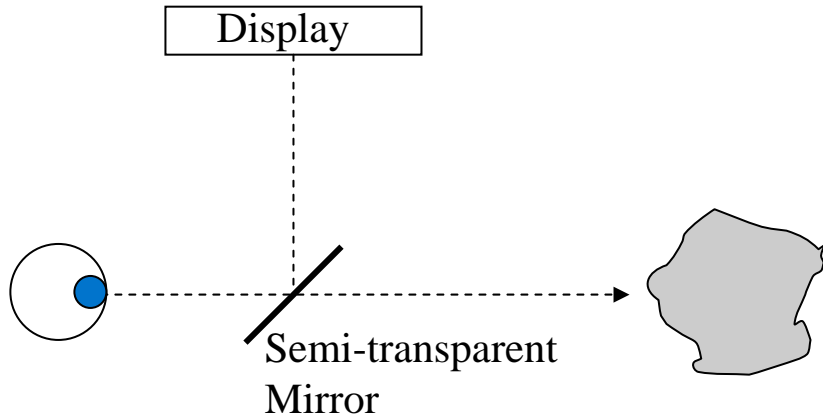

# Video See-Through HMD

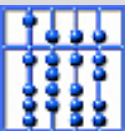
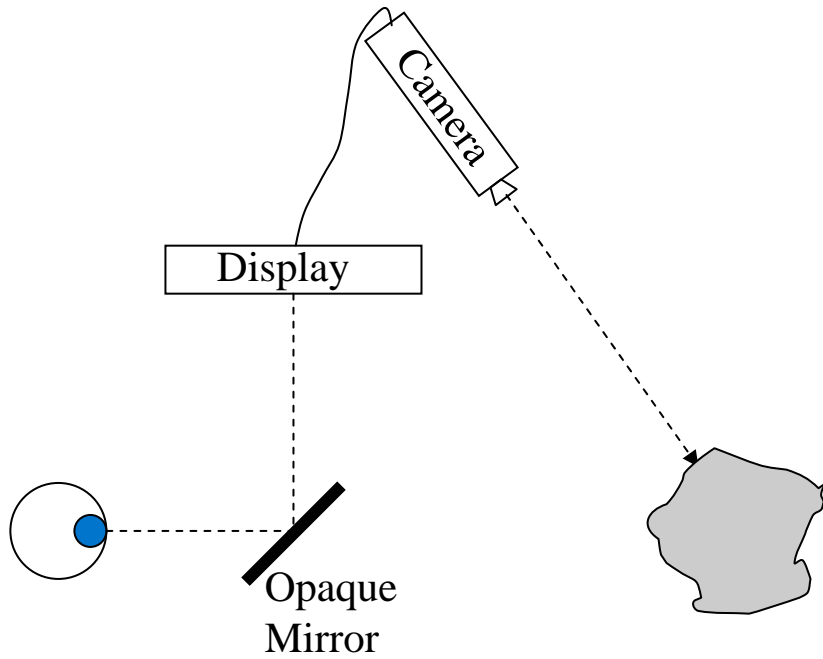

# 1. Technological Issues

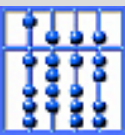

# 1.1 System Latency: Lag

## Requirements

Speed:  $> 25 \text{ Hz}$  ( $< 40 \text{ ms}$ )

Smooth rotation:  $100 \text{ deg/s}$

## State of the Art

- Optical See-Through HMDs
  - “Swimming”
  - Predictive tracking
- Video See-Through HMDs
  - Delay displaying “real image”
  - Until “virtual image” is rendered
  - Sensory conflicts (hand-eye)

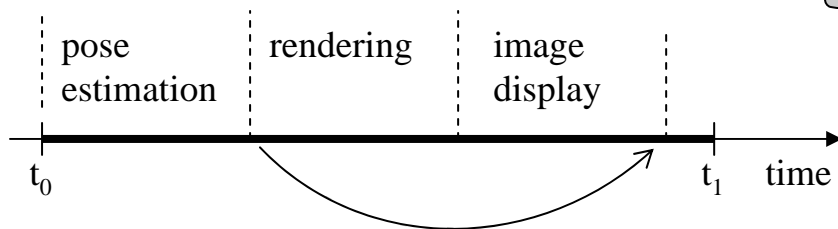
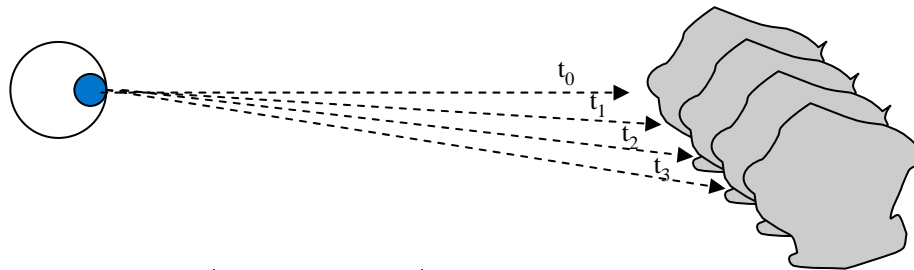

## Eye Tracking

- Simplified rendering during fast eye motion

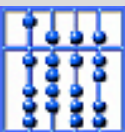



# 1.2 Real-Scene Resolution and Distortion

## Requirements

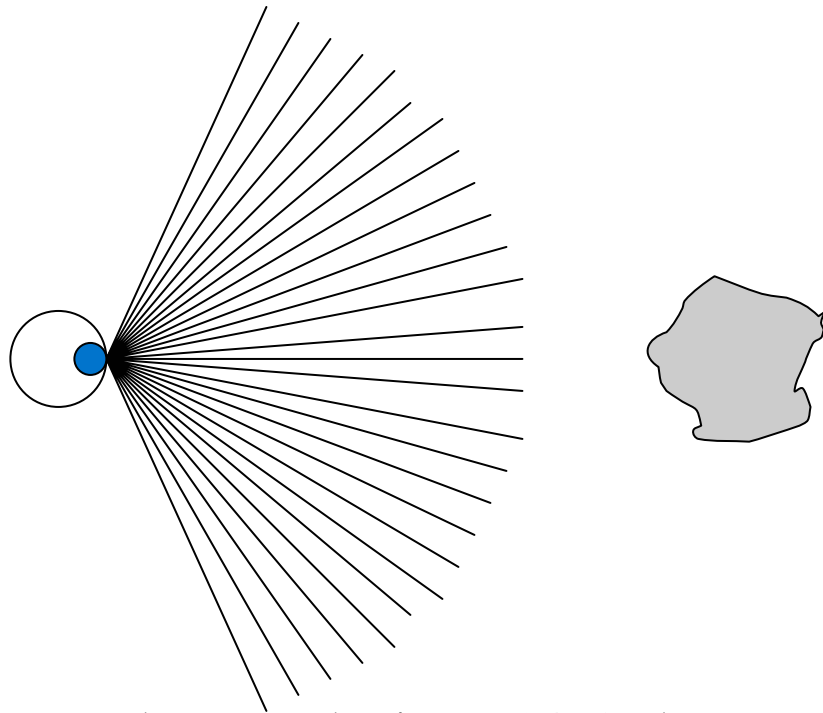

Angular resolution: 1/60 deg

## State of the Art

- Optical See-Through HMDs
  - 
  - 
  -
- Video See-Through HMDs
  - 
  - 
  -

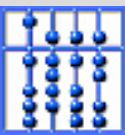

# 1.2 Real-Scene Resolution and Distortion

## Requirements

## State of the Art

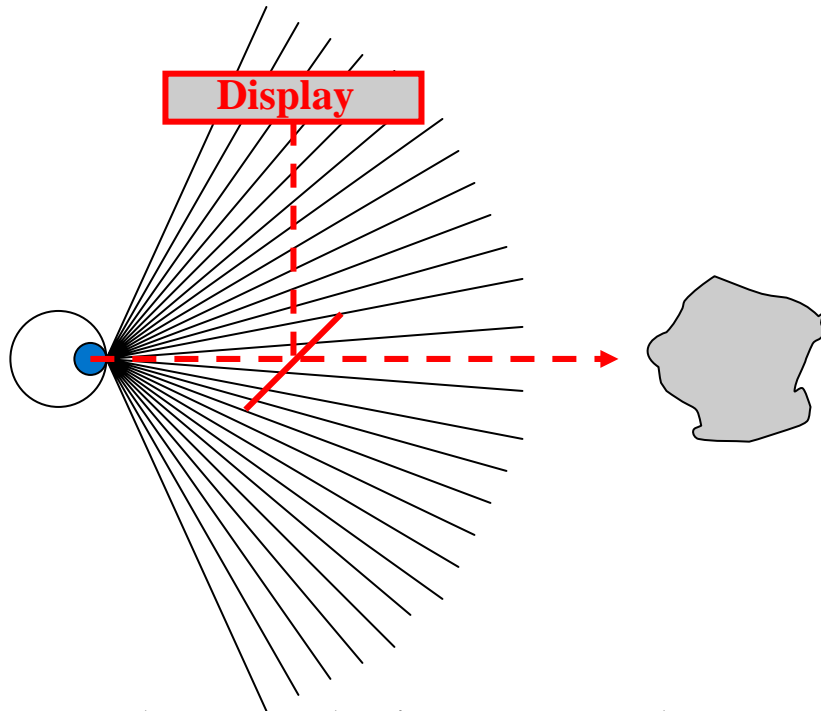

Angular resolution: 1/60 deg

- Optical See-Through HMDs
  - High resolution
  - Negligible distortion
  - Dimmed view
- Video See-Through HMDs
  - 
  - 
  -

# 1.2 Real-Scene Resolution and Distortion

## Requirements

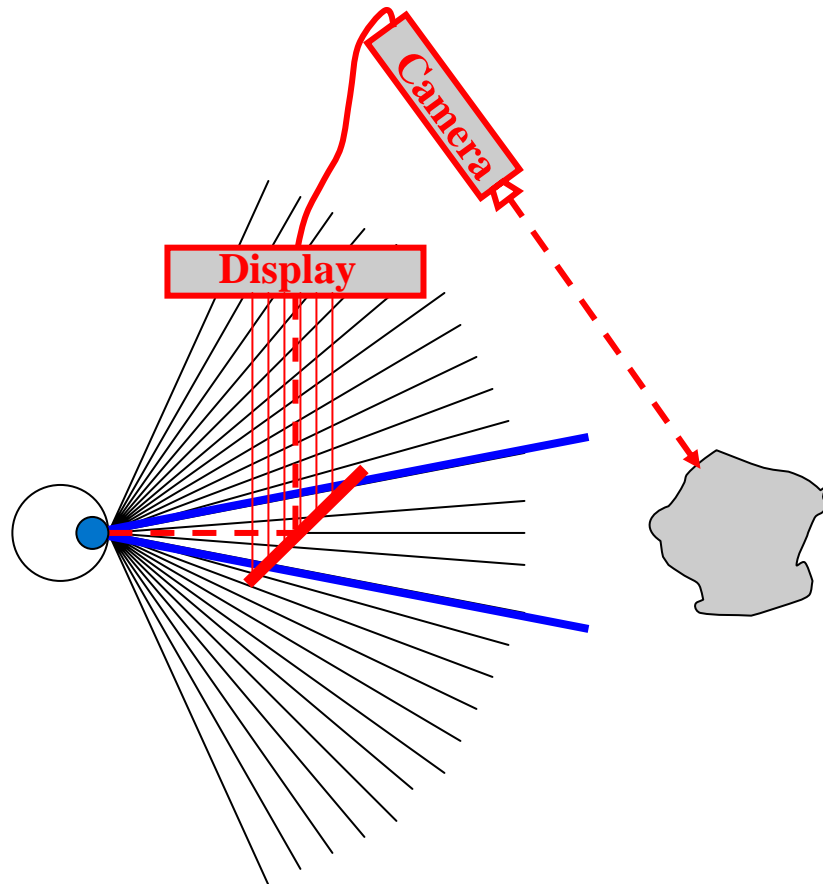

Angular resolution:  $1/60$  deg

## State of the Art

- Optical See-Through HMDs
  - High resolution
  - Negligible distortion
  - Dimmed view
- Video See-Through HMDs
  - 640 x 480 pixels
  - But, for 20 deg FOV:  
 $20 \times 60 = 1200$  pixels required
  - Distortion can be compensated

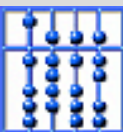

# 1.3 Field of View (FOV)

## Requirements

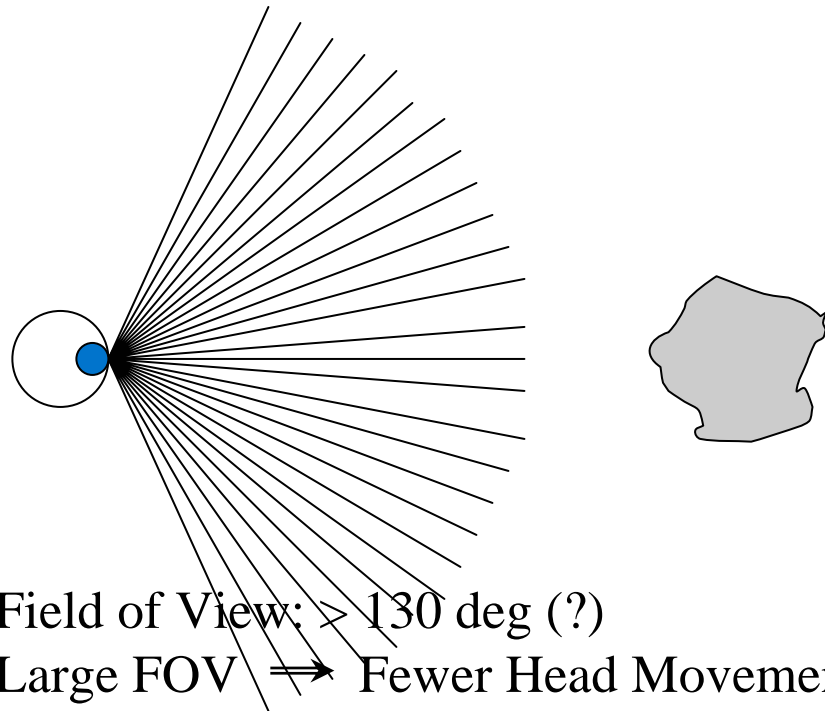

## State of the Art

- Optical See-Through HMDs
  - 
  -
- Video See-Through HMDs
  - 
  -

# 1.3 Field of View (FOV)

## Requirements

## State of the Art

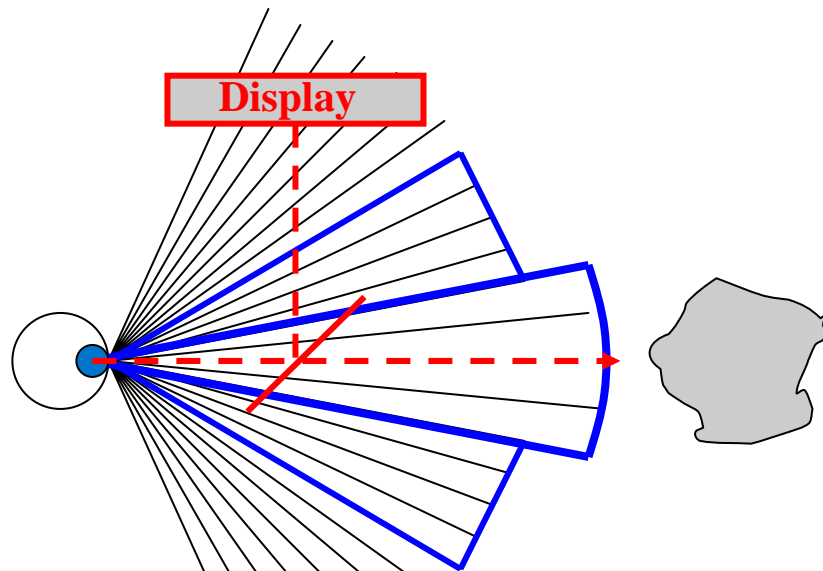

Field of View:  $> 130$  deg (?)

Large FOV  $\Rightarrow$  Fewer Head Movements

Greater Situation Awareness

- Optical See-Through HMDs
  - Overlay FOV: 20 - 60 deg (max.: 82.5 deg “massive tech.”)
  - Peripheral FOV
- Video See-Through HMDs
  - 
  -

# 1.3 Field of View (FOV)

## Requirements

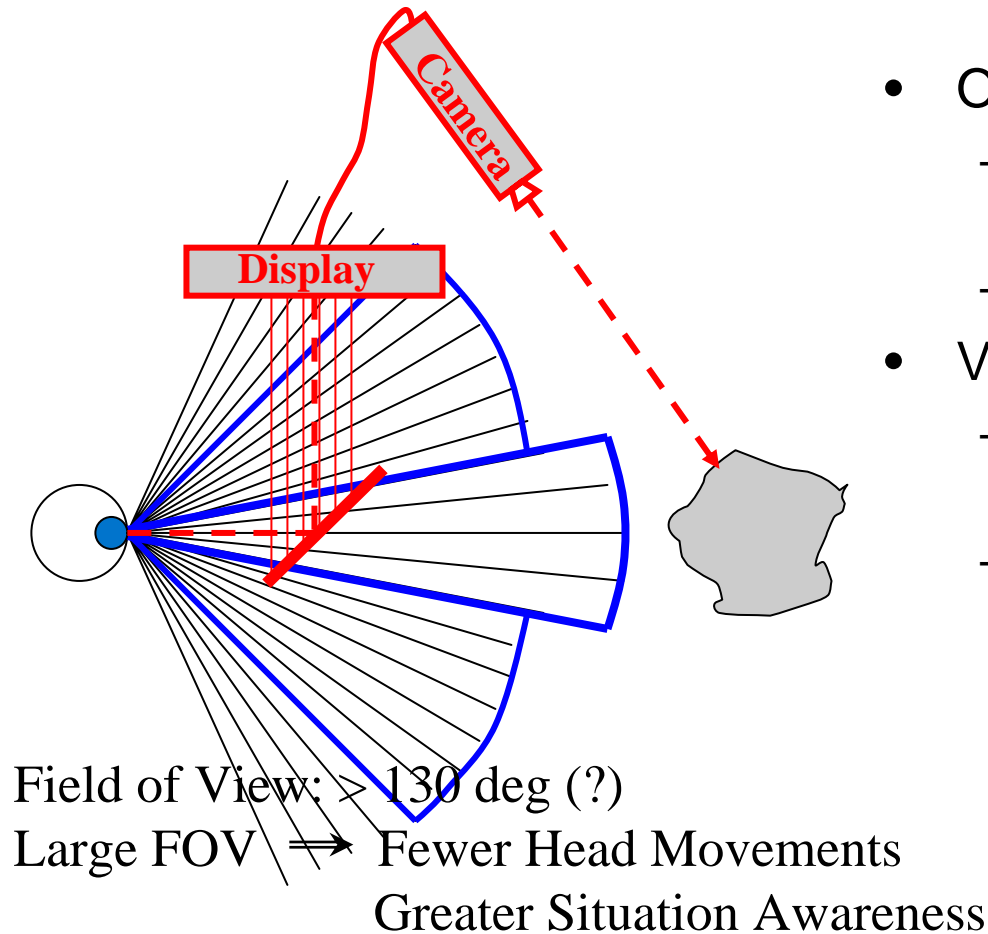

## State of the Art

- Optical See-Through HMDs
  - Overlay FOV: 20 - 60 deg (max.: 82.5 deg “massive tech.”)
  - Peripheral FOV
- Video See-Through HMDs
  - Overlay FOV: 20 - 90 deg (but generally small)
  - Peripheral FOV:
    - often excluded
    - otherwise: seamless transition!

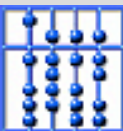

## Requirements

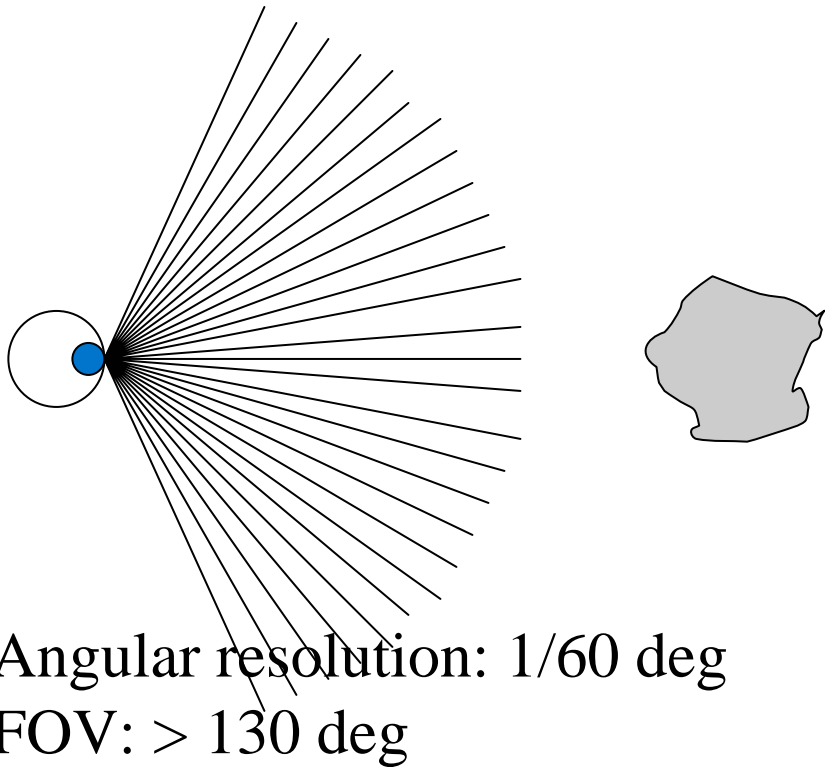

## State of the Art

- High-res trend: more resolution for smaller FOV
- Tiling: high res + large FOV (series of mini displays)
- High-res insets at center
- Head-Mounted Projective Displays: Beamer on your head

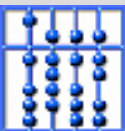

# 1.4 Viewpoint Matching

## Requirements

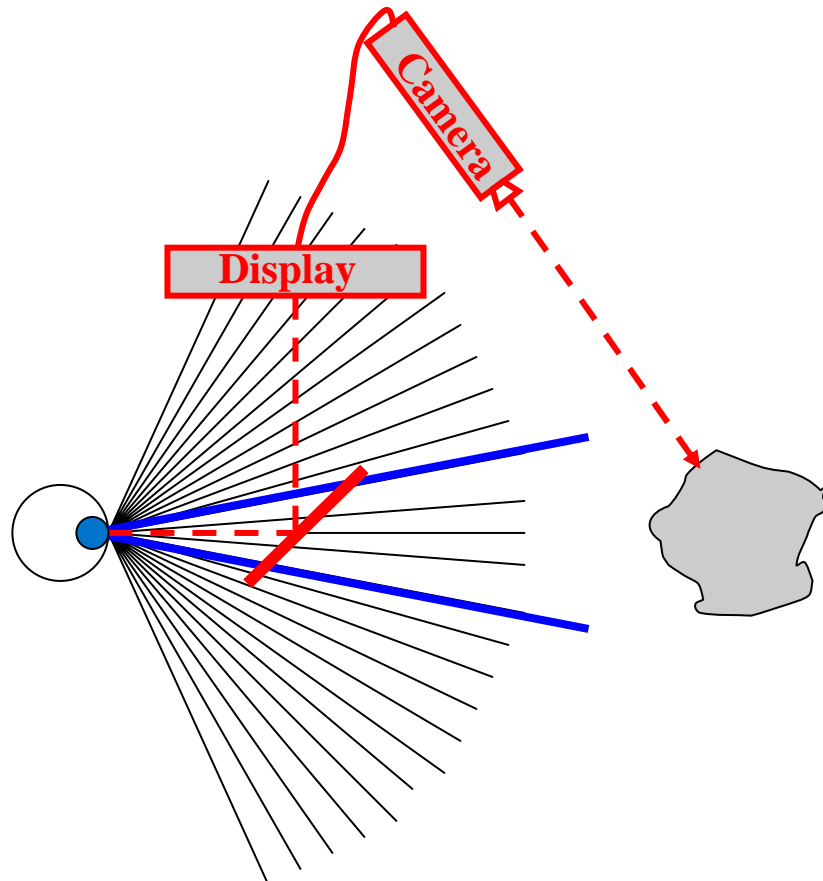

Camera View = User View !

## State of the Art

### Video See-Through HMDs

- Camera viewpoint must be matched with human eye.
- Spatial shift between video image and real scene.



# 1.4 Viewpoint Matching

## Requirements

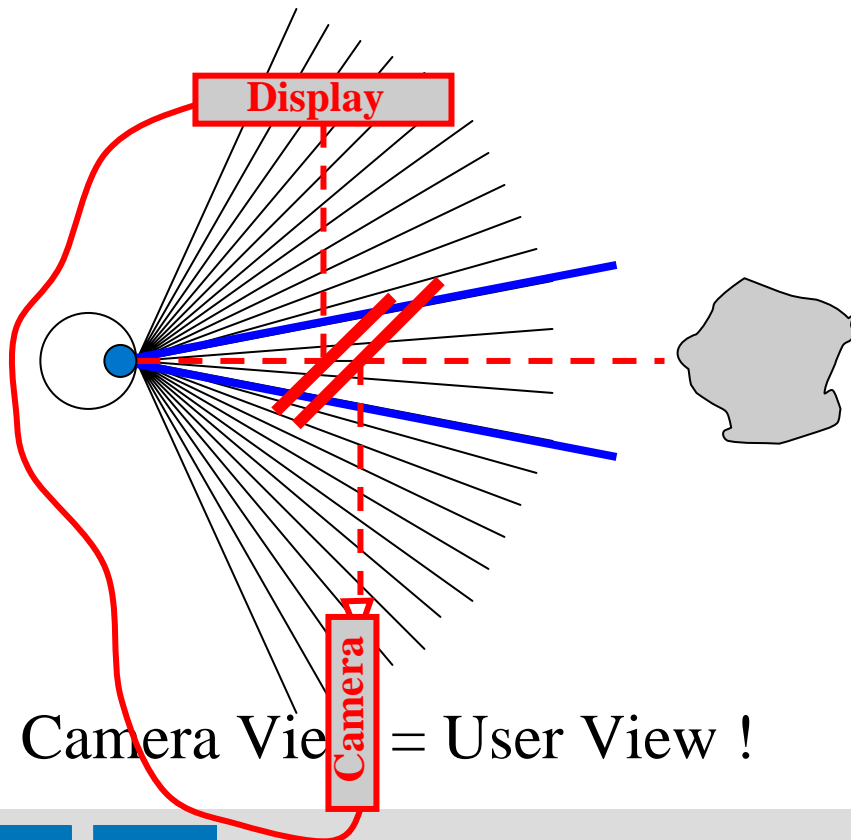

## State of the Art

### Video See-Through HMDs

- Spatial shift between video image and real scene
- Small FOV (< 20 deg): use mirrors to fold optical path
- Interpupillary Distance (IPD): cameras function of eye distance and eye movement

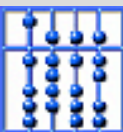

# 1.5 Engineering and Cost Factors

## Requirements

## State of the Art

- Low resolution
- Limited FOV (20 degrees)
- Poor ergonomic design
- Heavy weight

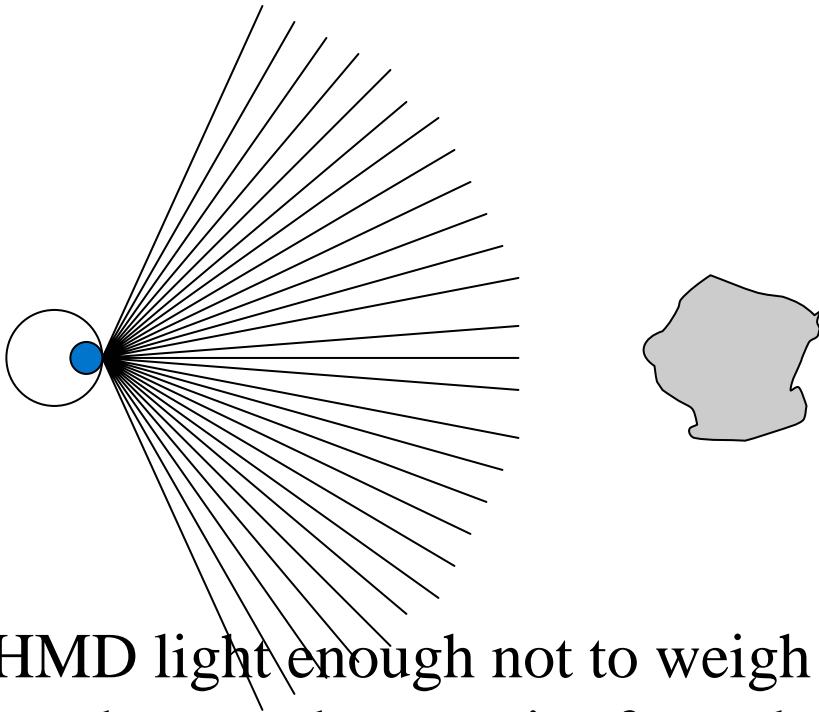

HMD light enough not to weigh much more than a pair of eyeglasses

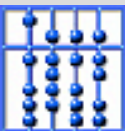

## 2. Human Factors and Perceptual Issues

1. User acceptance and safety
2. Depth perception
3. Adaptation
4. Peripheral FOV
5. Depth of field

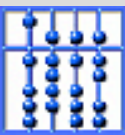

## 2.1 User Acceptance and Safety

### Requirements

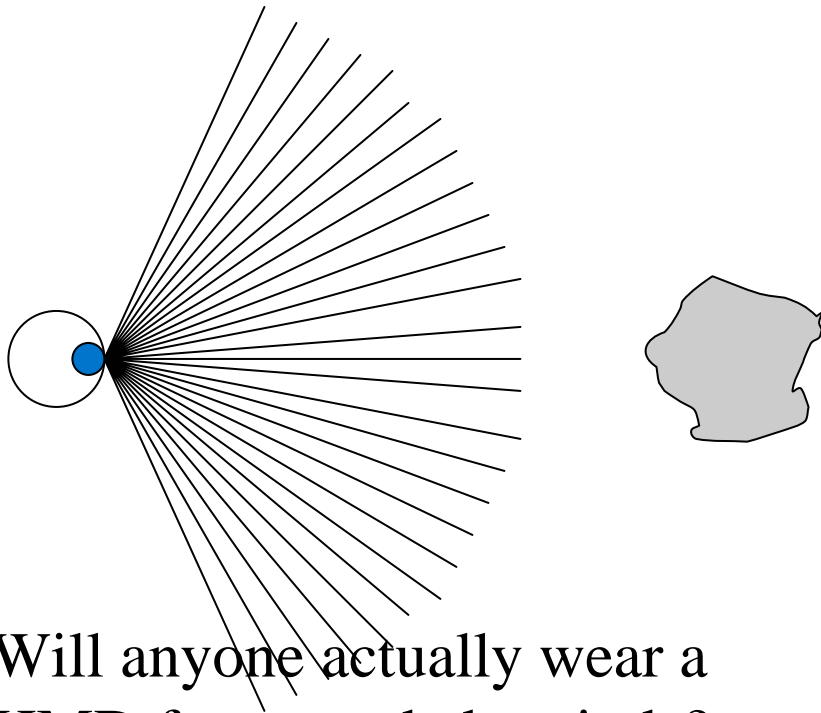

Will anyone actually wear a HMD for extended periods?

### Problems

- Video See-Through HMDs
  - Resistance in the work place
  - Lack of trust in safety-critical situations
  - Failure mode: No reality!
  - May be ok, if large peripheral FOV exists
  - Poor image quality
- Optical See-Through HMDs
  - Failure mode: Reality still there; but no augmentations

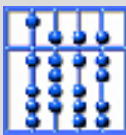

## 2.2 Depth Perception: Occlusion

### Requirements

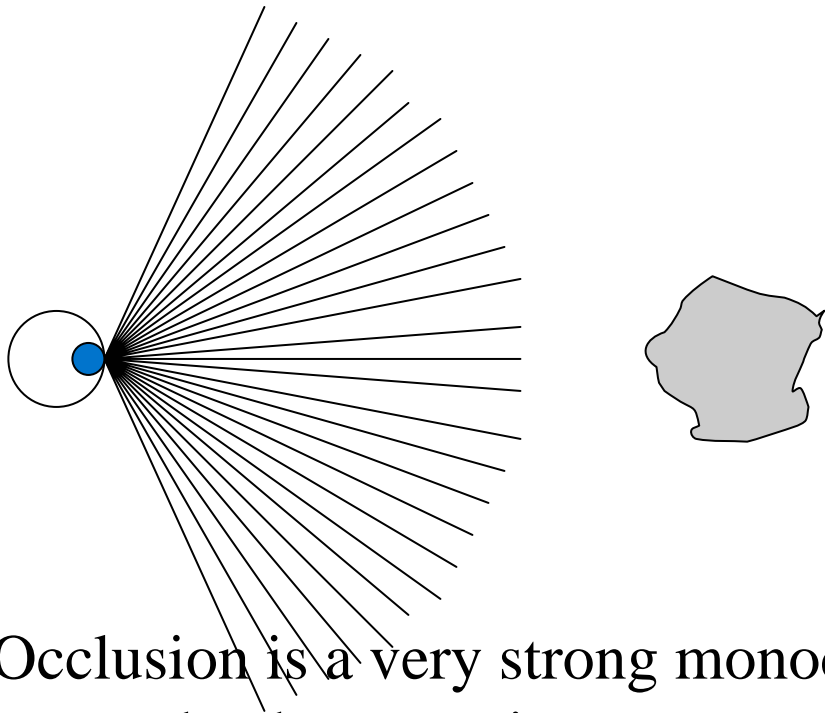

Occlusion is a very strong monocular cue to depth perception

### Description

- Prerequisite: dynamic reality model
- Optical See-Through HMDs
  - Occluded virtual objects: ok
  - Occluded real objects: cannot be completely erased; use beam splitters and change contrast between virtual and real images; controlled illumination
- Video See-Through HMDs
  - Occluded real objects: pixelwise overwrite or blend

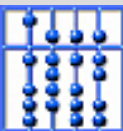

## 2.2 Depth Perception: Stereo Disparity

### Requirements

### Problems

- Inaccurate display calibration
- Wrong FOV estimation for HMD

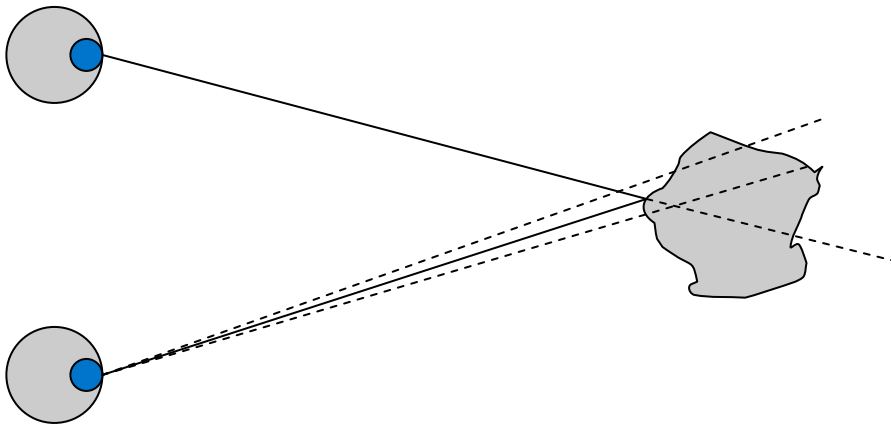

Where are the user's eyes?

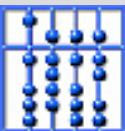

## 2.2 Depth Perception: Stereo Disparity

### Requirements

### Problems

- Inter-pupilar distance
- Wrong eyepoint location
  - Eyepoint: nodal point, pupil entrance or center of rotation (optical see-through)?
  - Aligned image acquisition for two eyes (video see-through)

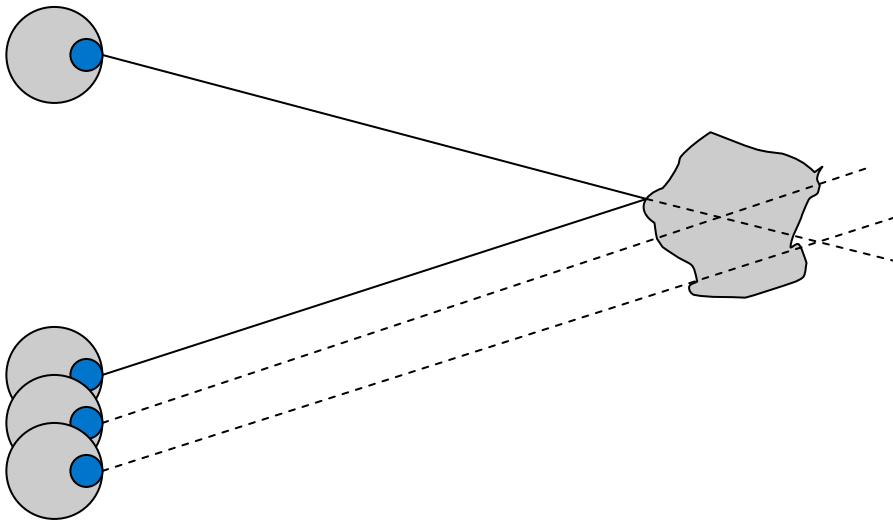

Where are the user's eyes?

## 2.2 Depth Perception: Convergence

### Requirements

### Description

- Both eyes turn inward (converge) or outward (diverge) such that the viewed objects are projected to the central area of the retina (fusional vergence)

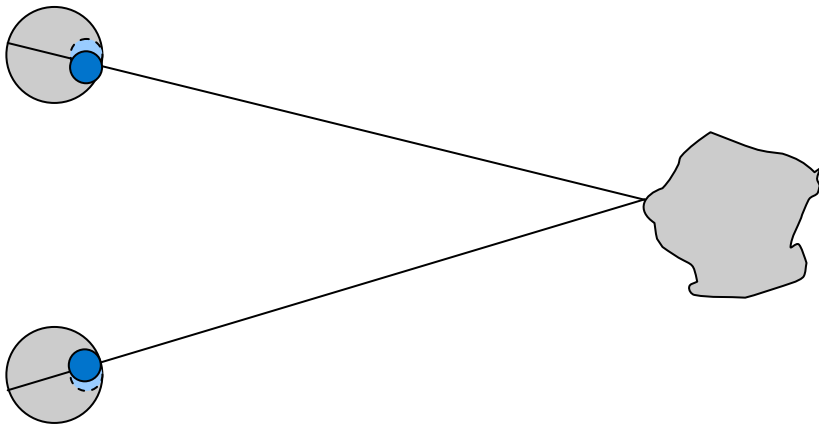

Convergence is a strong binocular cue to depth perception

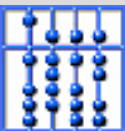



## 2.2 Depth Perception: Accomodation

### Requirements

### Description

- The lens of an eye contracts or extends in order to see the object as sharply as possible

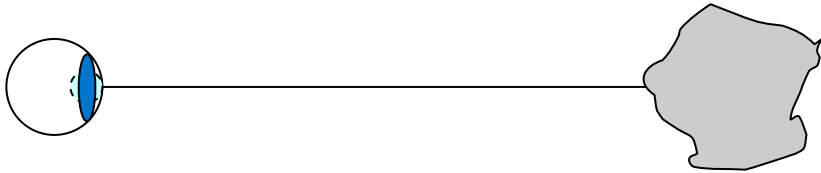

Accomodation is a strong monocular cue to depth perception

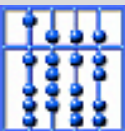

## 2.3 Adaptation

### Requirements

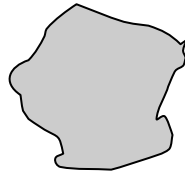
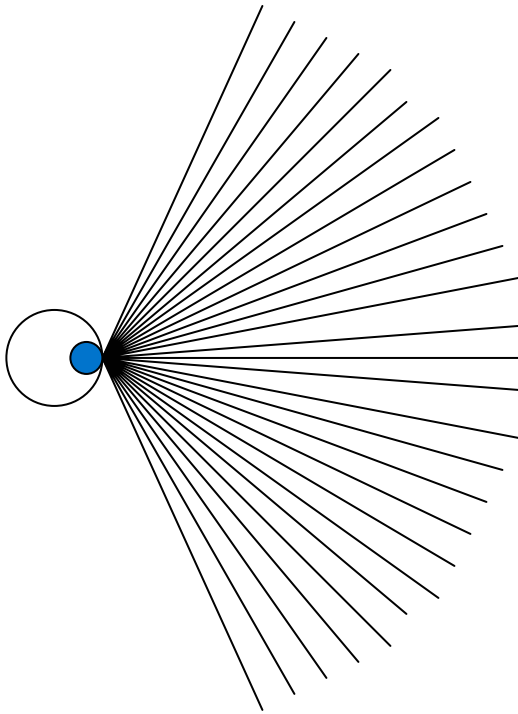

### Description

- Adaptation to visual displacement (Video See-Through)
  - Increasing performance over time
  - Negative aftereffects
- Adaptation to conflicting cues („mixed signals“)
- Implications of aftereffects
  - Recovery period after HMD use
  - Duration?
  - Gradual or dual adaptation?

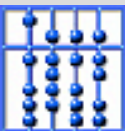

## 2.4 Peripheral FOV

### Requirements

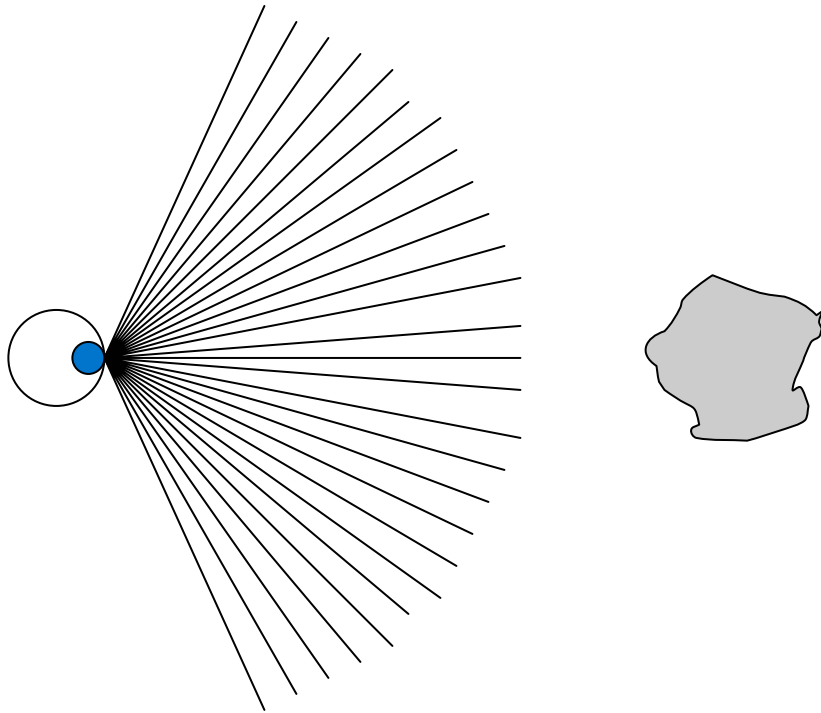

### State of the Art

- Optical See-Through HMDs
  - Intuitive
- Video See-Through HMDs
  - User can see around the video area
  - Questions regarding the different presentation style in overlay (video) and peripheral (optical) area:
    - Different accommodation efforts for user!
    - Conflicting cues?
    - Discomfort?

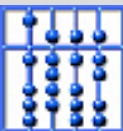

## 2.5 Depth of Field

### Requirements

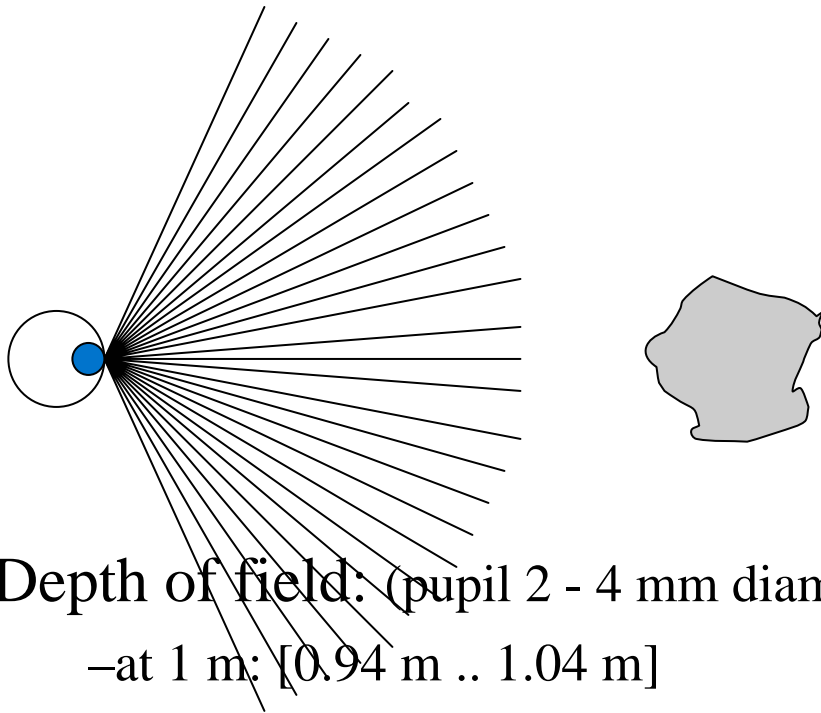

Depth of field: (pupil 2 - 4 mm diameter)

–at 1 m: [0.94 m .. 1.04 m]

–at 17 m: [11 m .. 33 m]

### State of the Art

- The larger the depth of field, the smaller the need for accommodation
- Accommodation plays an important role at close working distance
- Video See-Through HMDs
  - Cameras must have depth of field according to current working distance (autofocus?)
- Optical See-Through HMDs
  - User's pupil enlarged due to reduced light --> smaller depth of field
  - Problem: real/virtual objects at different depths

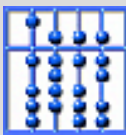

# 3. Other Displays for Augmented Reality

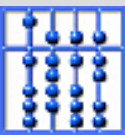

# Summary: Limitations of Current HMDs

- Resolution
- Field of View
- Contrast
- Weight
- Cables
  
- Issues
  - User safety
  - User comfort
  - Shared views for collaborative discussions

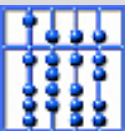

# Augmented Reality: Yes, But Where?



- In front of a user's eyes: "Classical AR"
  - HMDs



[FhG-IGD 97]

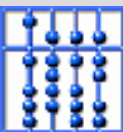

# Augmented Reality: Yes, But Where?



- In front of a user's eyes: "Classical AR"
  - HMDs
- On a portable display: "Window into the world"
  - Palmtops, cellular phones, tablet PCs
  - Intelligent instruments

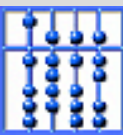
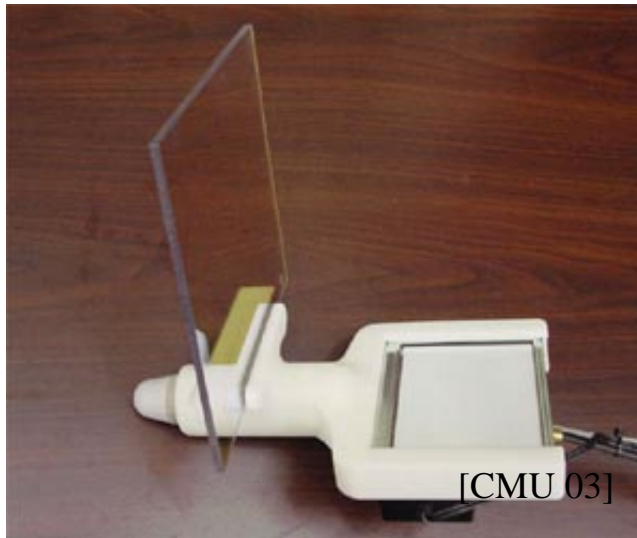



# Augmented Reality: Yes, But Where?



- In front of a user's eyes: "Classical AR"
  - HMDs
- On a portable display: "Window into the world"
  - Palmtops, cellular phones, tablet PCs
  - Intelligent instruments
- On stationary monitors: "Intelligent environments"
  - See-through displays integrated into a work area
  - Wall-mounted displays

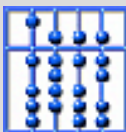

# Augmented Reality: Yes, But Where?



- In front of a user's eyes: "Classical AR"
  - HMDs
- On a portable display: "Window into the world"
  - Palmtops, cellular phones, tablet PCs
  - Intelligent instruments
- On stationary monitors: "Intelligent environments"
  - See-through displays integrated into a work area
  - Wall-mounted displays
- On real objects:  
"Virtual showcase"
  - Projectors

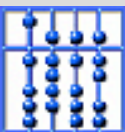

# SHEEP

