

Einführung in die Erweiterte Realität

- 6. Head-Mounted Displays -

Gudrun Klinker

Nov. 25, 2003

Agenda

“Optical versus Video See-Through Head-Mounted Displays”, J.P Rolland and H. Fuchs, in Fundamentals of Wearable Computers and Augmented Reality (chap. 4), 2001, pp.113-156

The Human Eye

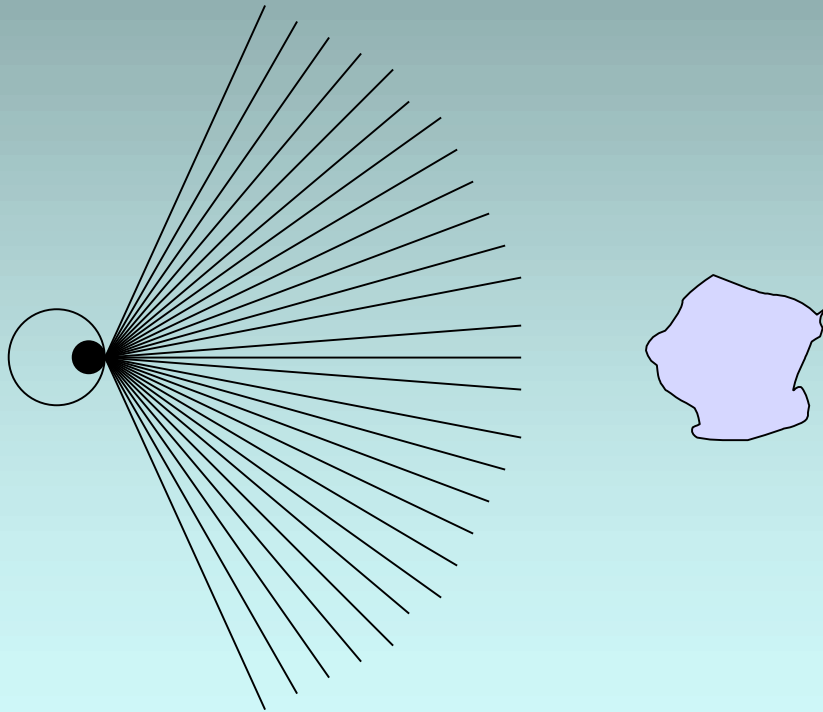

- Speed: > 25 Hz (< 40 ms)
- Smooth rotation: 100 deg/s
- Center of eye rotation ???
- Angular resolution: $1/60$ deg
- Field of View: > 130 deg (?)
- Depth of field:
(pupil 2 - 4 mm diameter)
 - at 1 m: [0.94 m .. 1.04 m]
 - at 17 m: [11 m .. 33 m]
- Distance between eyes

Optical See-Through HMD

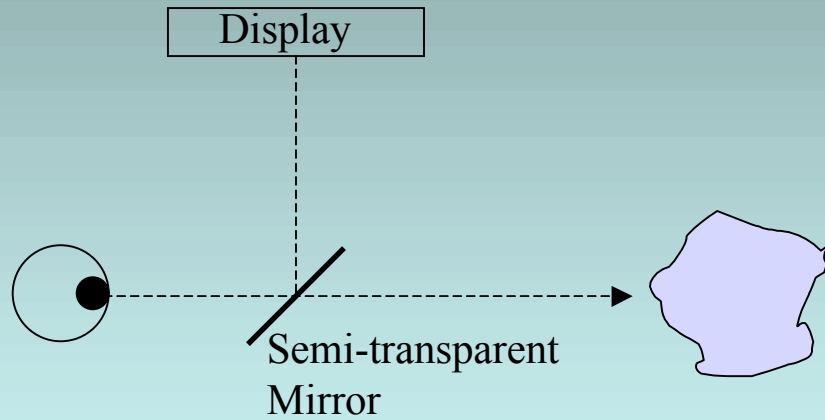

Video See-Through HMD

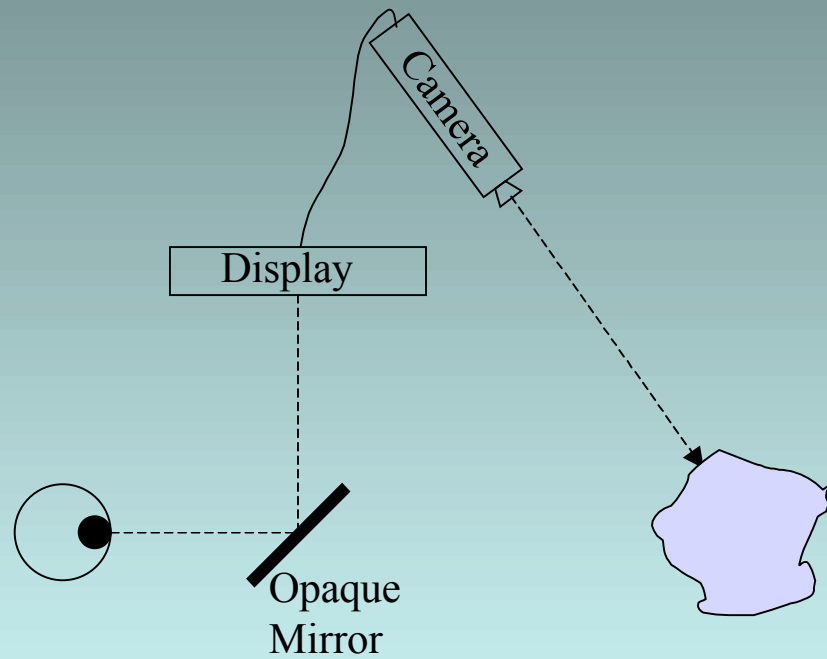

Issues

1. Technological

1. System latency
2. Real scene resolution and distortions
3. Field of view
4. Eyepoint matching
5. Engineering and cost factors

2. Human factors / perceptual

1. User acceptance, safety
2. Perceived depth
3. Adaptation
4. Peripheral field of view
5. Depth of field
6. Qualitative aspects

1. Technological Issues

1.1 System Latency: Lag

Requirements

Speed: > 25 Hz (< 40 ms)

Smooth rotation: 100 deg/s

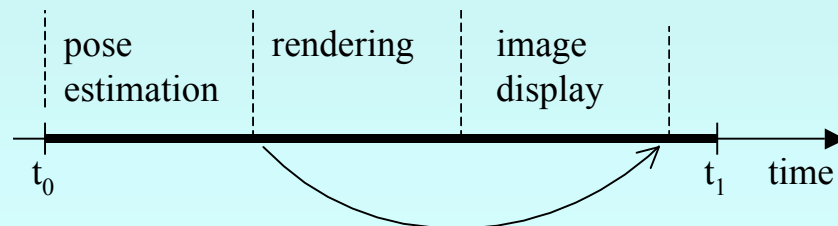
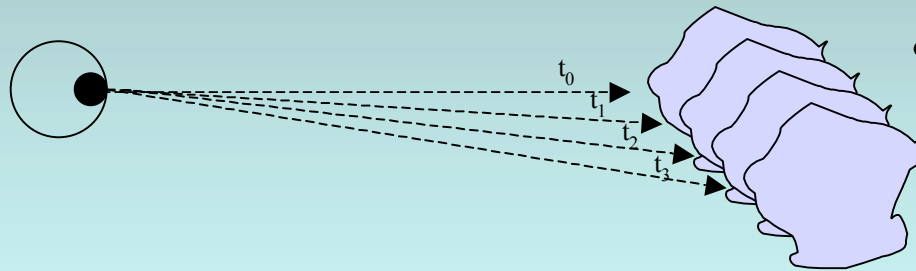

State of the Art

- Optical See-Through HMDs
 - “Swimming”
 - Predictive tracking
- Video See-Through HMDs
 - Delay displaying “real image”
 - Until “virtual image” is rendered
 - Sensory conflicts (hand-eye)
- Eye Tracking
 - Simplified rendering during fast eye motion

1.2 Real-Scene Resolution and Distortion

Requirements

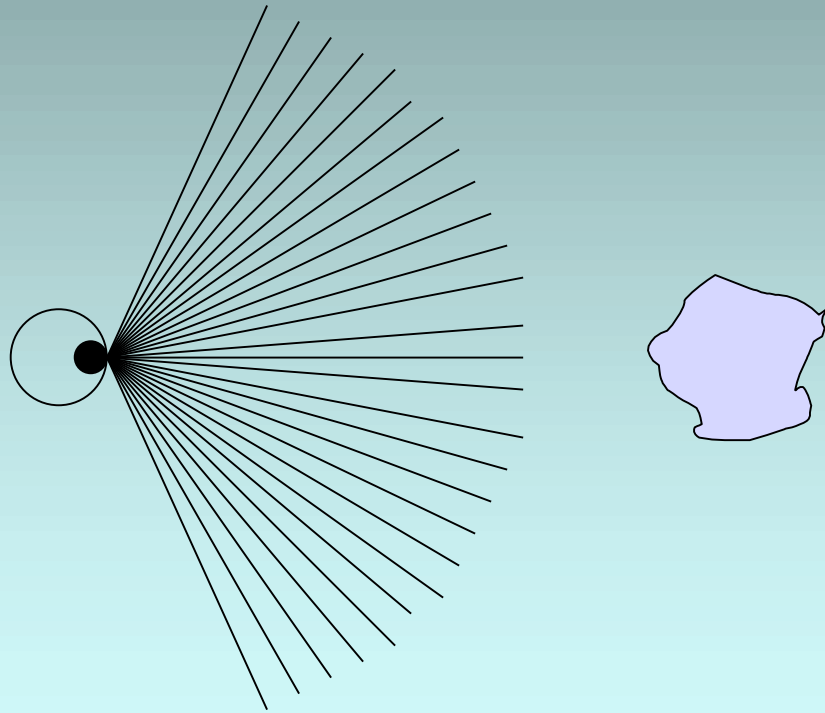

Angular resolution: $1/60$ deg

State of the Art

- Optical See-Through HMDs
 -
 -
 -
- Video See-Through HMDs
 -
 -
 -

1.2 Real-Scene Resolution and Distortion

Requirements

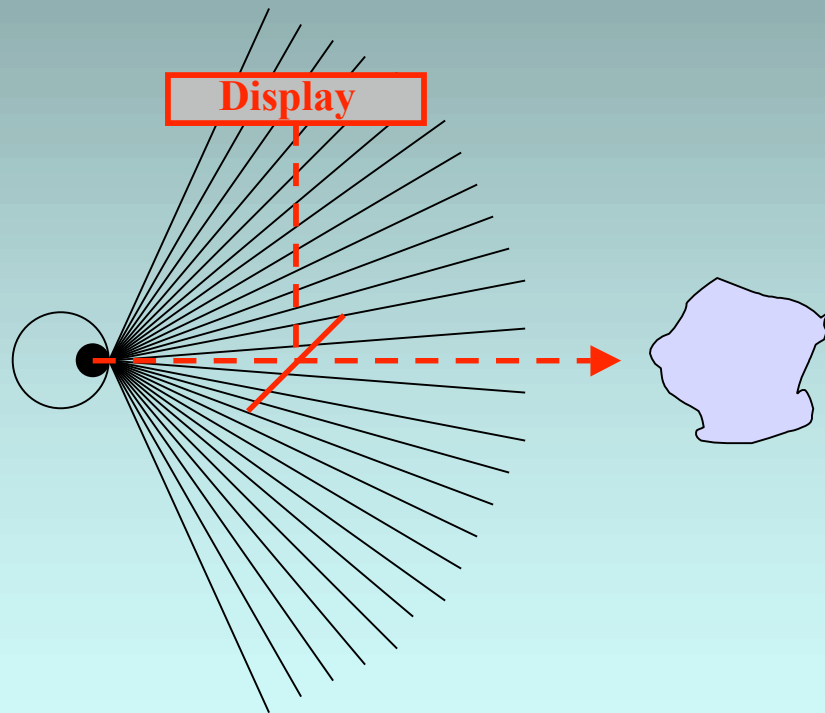

Angular resolution: $1/60$ deg

State of the Art

- Optical See-Through HMDs
 - High resolution
 - Negligible distortion
 - Dimmed view
- Video See-Through HMDs
 -
 -
 -

1.2 Real-Scene Resolution and Distortion

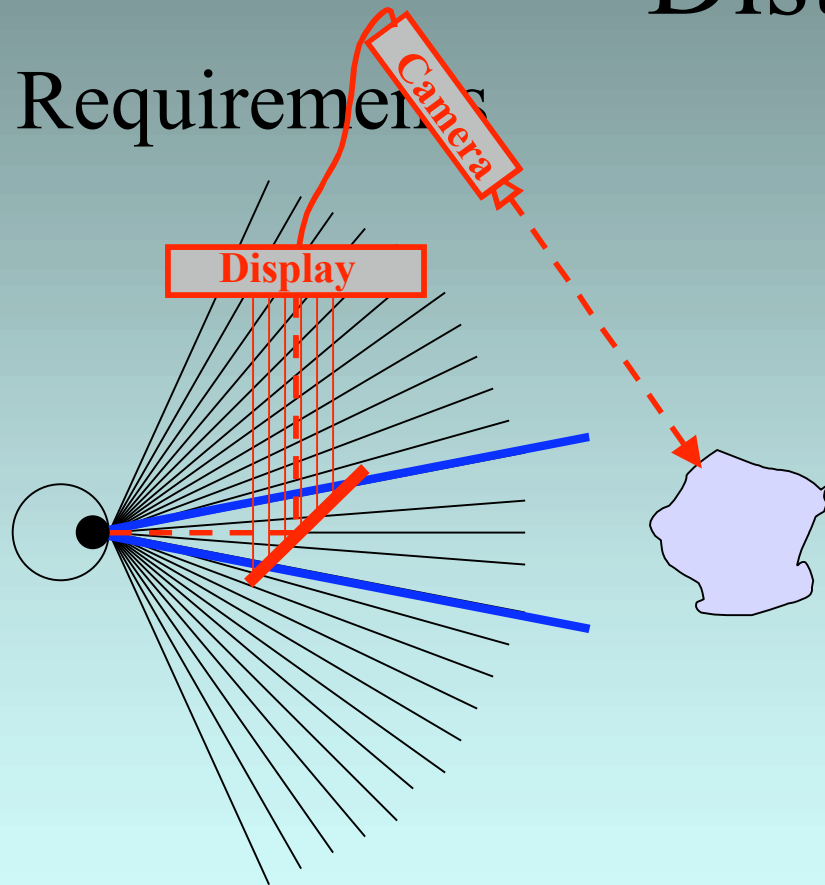

Angular resolution: $1/60$ deg

State of the Art

- Optical See-Through HMDs
 - High resolution
 - Negligible distortion
 - Dimmed view
- Video See-Through HMDs
 - 640 x 480 pixels
 - But, for 20 deg FOV:
 $20 * 60 = 1200$ pixels required
 - Distortion can be compensated

1.3 Field of View (FOV)

Requirements

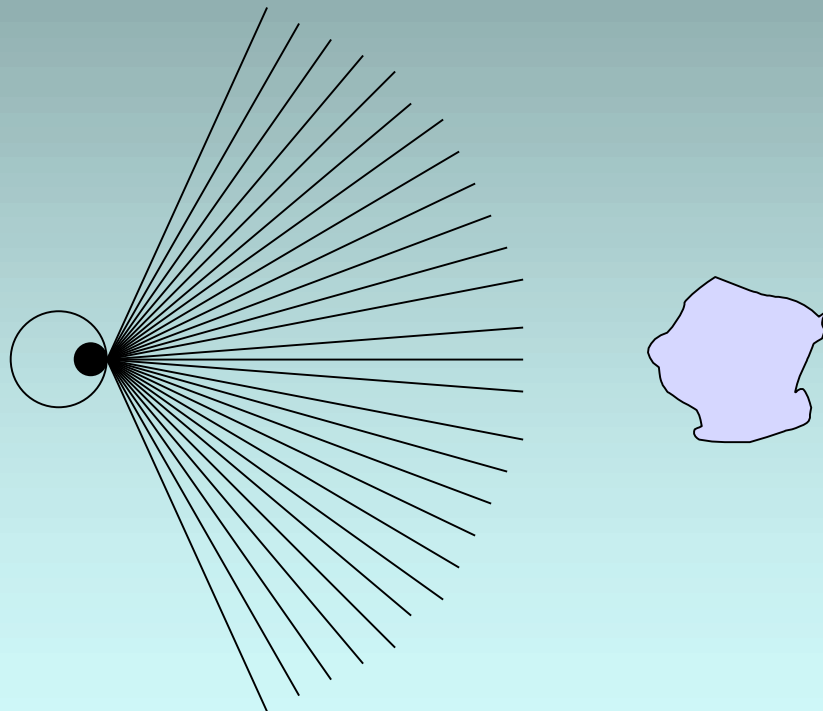

Field of View: > 130 deg (?)

Large FOV

⇒ Fewer Head Movements

Greater Situation Awareness

State of the Art

- Optical See-Through HMDs
 -
 -
- Video See-Through HMDs
 -
 -

1.3 Field of View (FOV)

Requirements

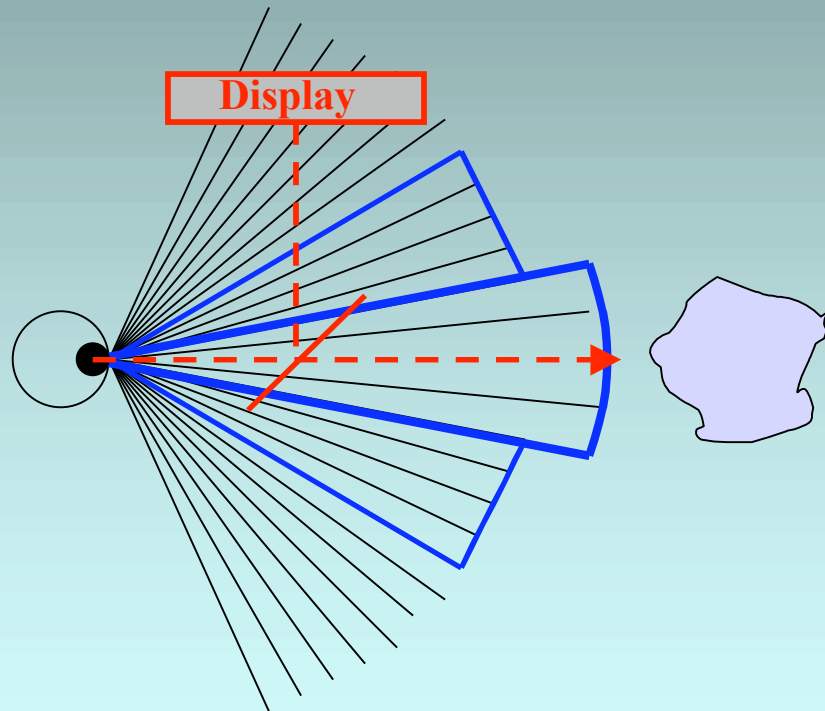

Field of View: > 130 deg (?)

Large FOV

⇒ Fewer Head Movements

Greater Situation Awareness

State of the Art

- Optical See-Through HMDs
 - Overlay FOV: 20 - 60 deg (max.: 82.5 deg “massive tech.”)
 - Peripheral FOV
- Video See-Through HMDs
 -
 -

1.3 Field of View (FOV)

Requirements

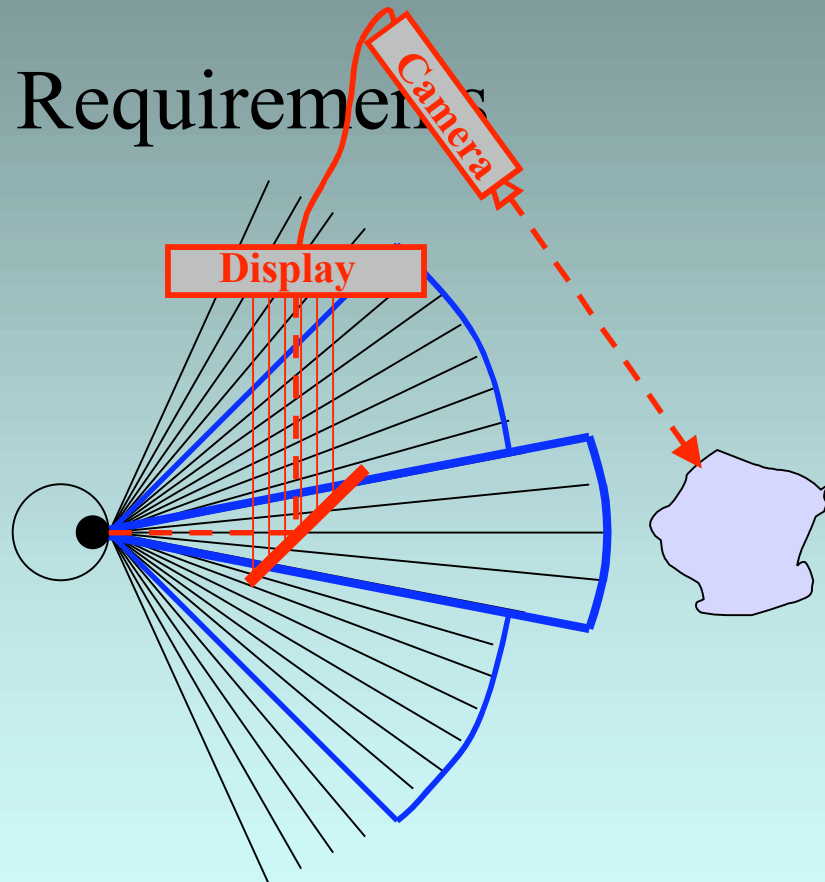

Field of View: > 130 deg (?)

Large FOV

⇒ Fewer Head Movements

Greater Situation Awareness

State of the Art

- Optical See-Through HMDs
 - Overlay FOV: 20 - 60 deg (max.: 82.5 deg “massive tech.”)
 - Peripheral FOV
- Video See-Through HMDs
 - Overlay FOV: 20 - 90 deg (but generally small)
 - Peripheral FOV:
 - often excluded
 - otherwise: seamless transition!

Resolution vs. FOV

Requirements

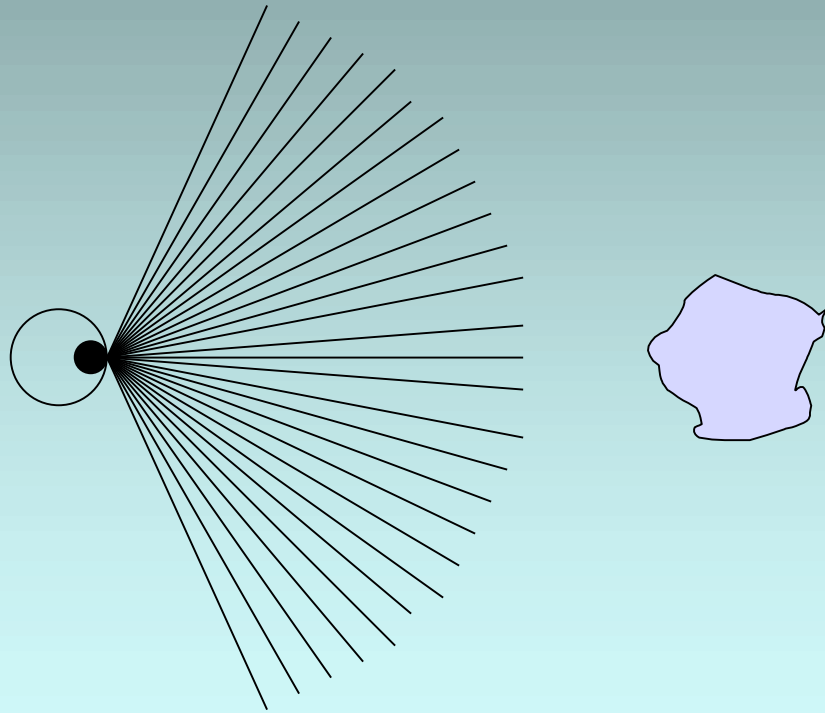

Angular resolution: $1/60$ deg
FOV: > 130 deg

State of the Art

- High-res trend: more resolution for less FOV
- Tiling: high res + large FOV (series of mini displays)
- High-res insets at center
- Head-Mounted Projective Displays: Beamer on your head

1.4 Viewpoint Matching

Requirements

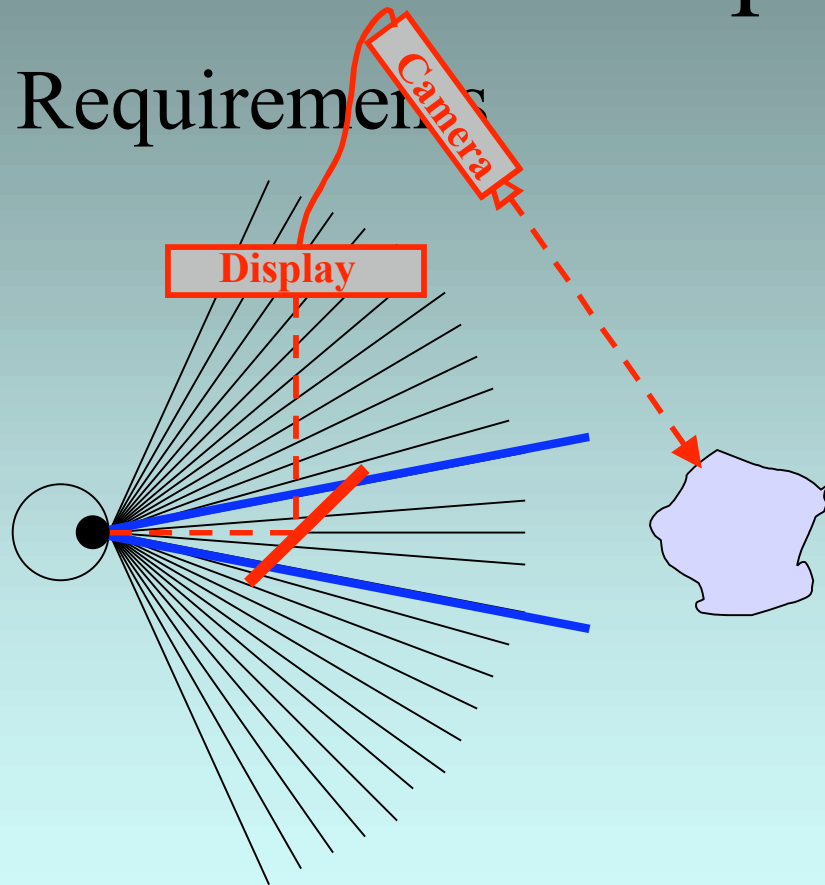

State of the Art

Video See-Through HMDs

- Camera viewpoint must be matched with human eye.
- Spatial shift between video image and real scene.

Camera View = User View !

1.4 Viewpoint Matching

Requirements

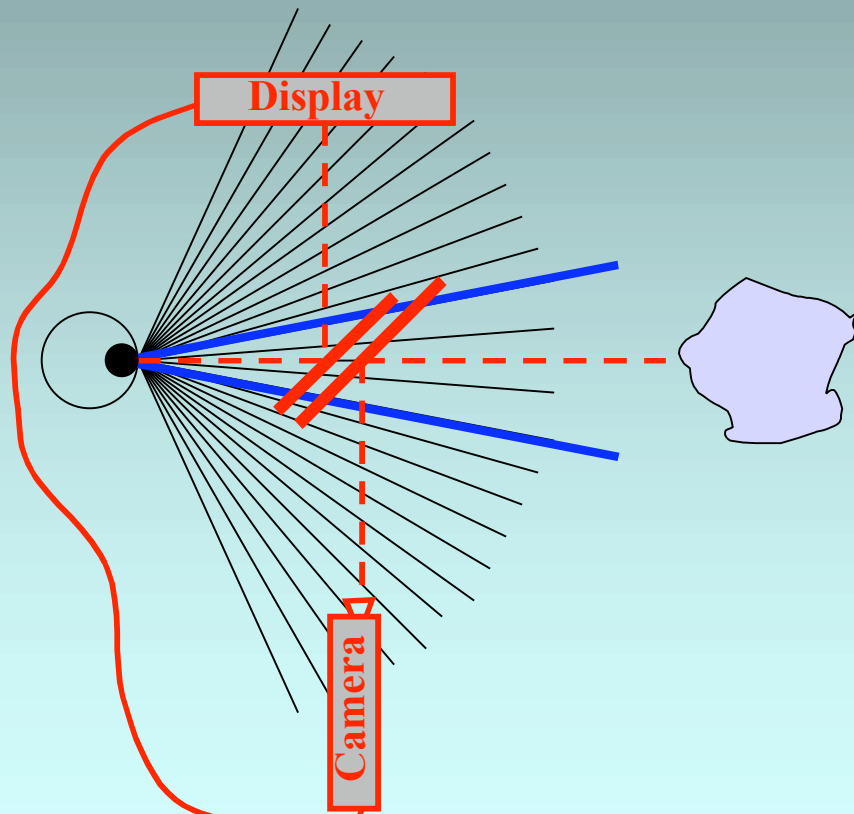

Camera View = User View !

State of the Art

Video See-Through HMDs

- Spatial shift between video image and real scene
- Small FOV (< 20 deg): use mirrors to fold optical path
- Interpupillary Distance (IPD): cameras function of eye distance and eye movement

1.5 Engineering and Cost Factors

Requirements

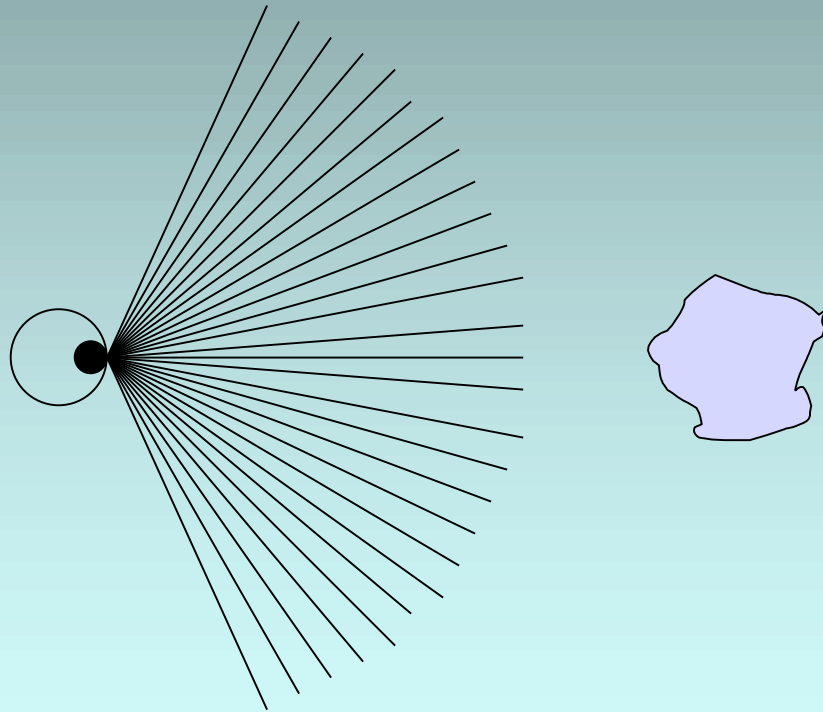

HMD light enough to not weigh much more than a pair of eyeglasses

State of the Art

- Low resolution
- Limited FOV (20 degrees)
- Poor ergonomic design
- Heavy weight
- Folding (optical see-through)
 - on-axis design: ghost images
 - off-axis design: better, but difficult to design and build; generally classified; very expensive

2. Human Factors and Perceptual Issues

1. User acceptance and safety
2. Depth perception
 - Occlusion
 - Stereo display errors
 - Field of view, buffer overscan
 - Eyepoint location
 - Residual optical distortions
 - Perceived depth of object position
3. Adaptation
4. Peripheral FOV
5. Depth of field
6. Qualitative aspects

2.1 User Acceptance and Safety

Requirements

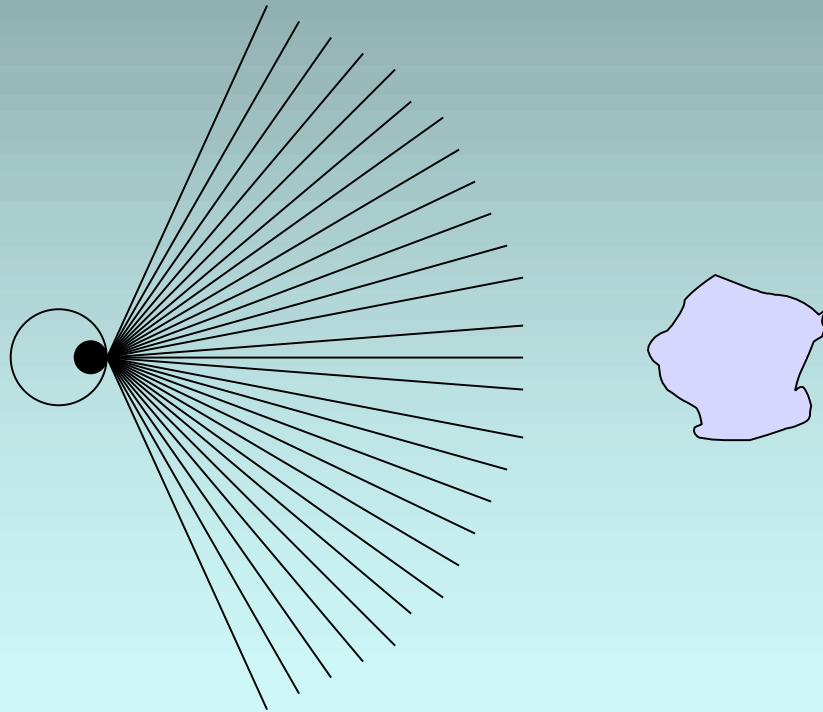

Will anyone actually wear a HMD for extended periods?

State of the Art

- Video See-Through HMDs
 - Resistance in the work place
 - Lack of trust in safety-critical situations
 - Failure mode: No reality!
 - May be ok, if large peripheral FOV exists
 - Poor image quality
- Optical See-Through HMDs
 - Failure mode: Reality still there; but no augmentations

2.2 Depth Perception: Occlusion

Requirements

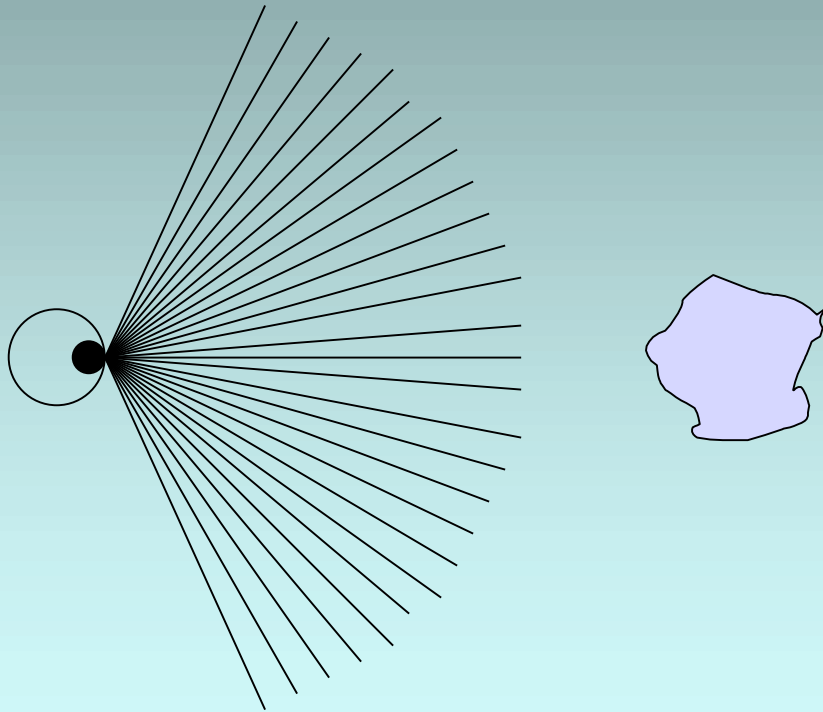

Occlusion is a very strong monocular cue to depth perception

State of the Art

- Prerequisite: dynamic reality model
- Optical See-Through HMDs
 - Occluded virtual objects: ok
 - Occluded real objects: cannot be completely erased; use beam splitters and change contrast between virtual and real images; controlled illumination
- Video See-Through HMDs
 - Occluded real objects: pixelwise overwrite or blend

2.2 Depth Perception: Stereo Display Errors

Requirements

State of the Art

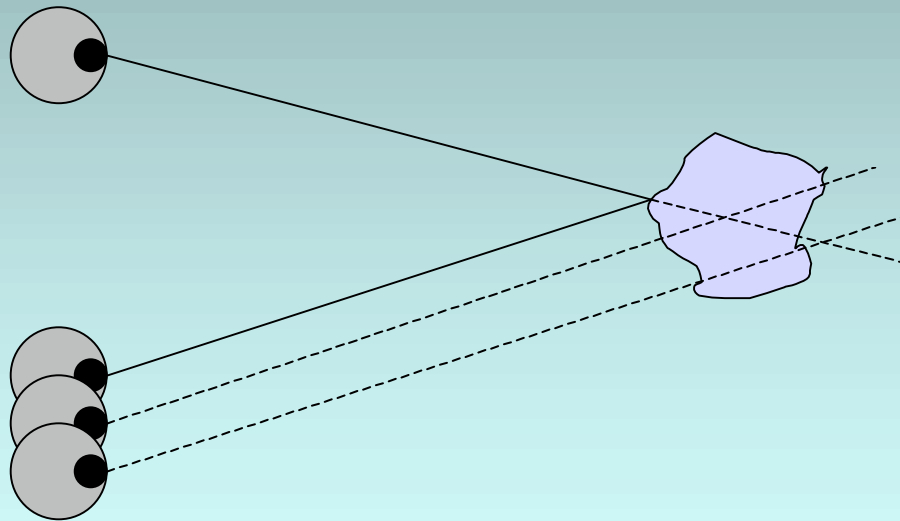

- Inaccurate display calibration (e.g., FOV)
- Eyepoint location
- Conflicting or incompatible depth cues
- Optical aberrations (residual distortions)

Exact descriptions of user,
cameras and displays

2.2 Depth Perception: FOV, Buffer Overscan

Requirements

State of the Art

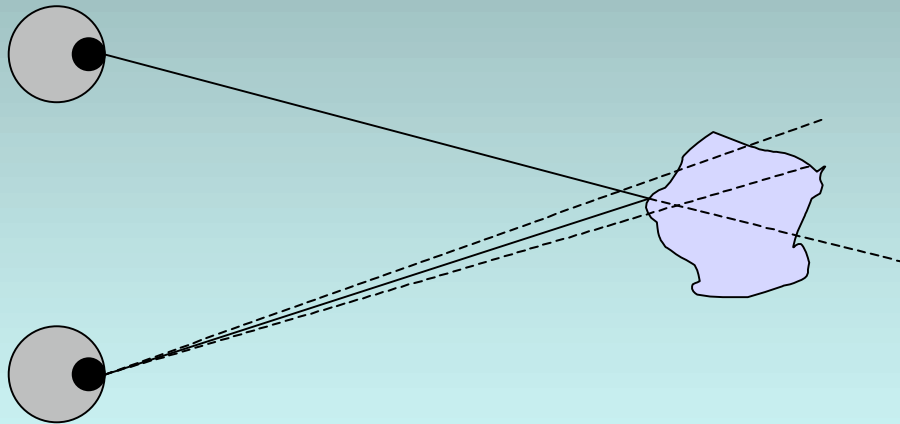

- Wrong FOV estimation for HMD
- Buffer overscan: not square pixels

2.2 Depth Perception: Eyepoint Location

Requirements

State of the Art

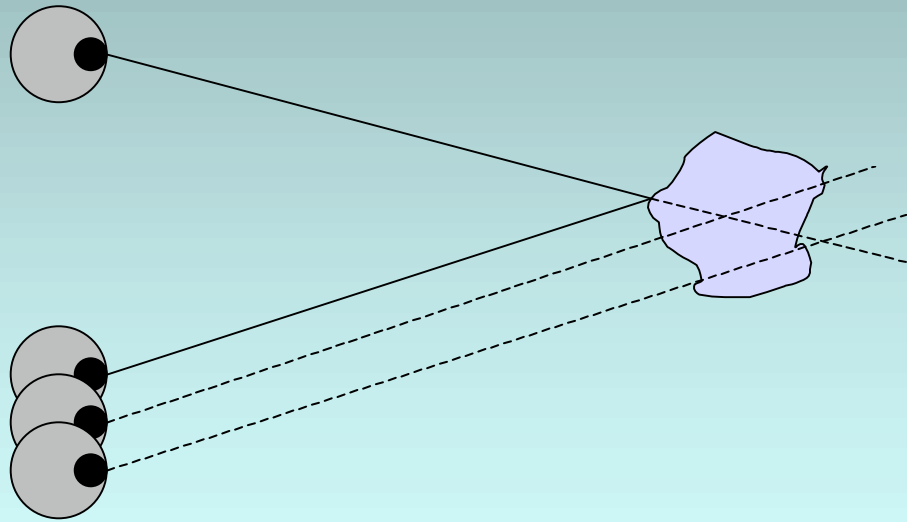

- Optical See-Through HMDs
 - Alignment: Eyes-Displays
 - Eyepoint: nodal point, entrance pupil, center of rotation
- Video See-Through HMDs
 - Alignment: Eyes-Displays
 - Aligned image acquisition

Where are the user's eyes?

2.2 Depth Perception: Residual Optical Distortions

Requirements

State of the Art

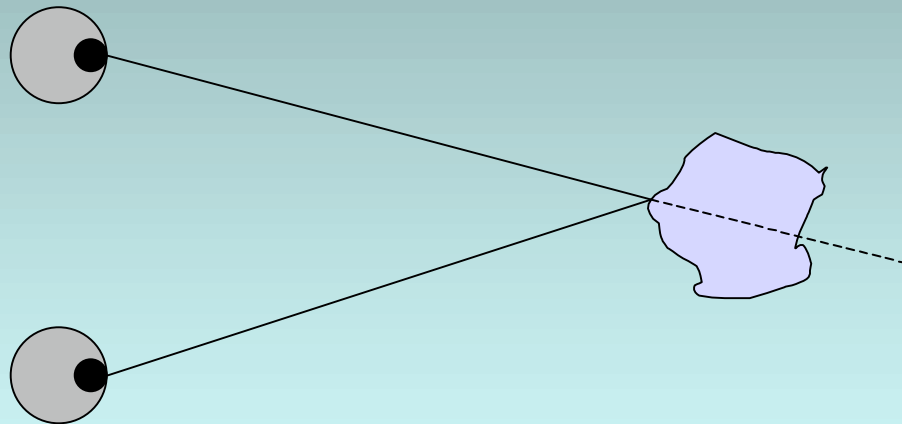

- Optical distortion: image warping (only for lenses with curved mirrors)

2.2 Depth Perception:

Perceived Depth of Object Position

Requirements

State of the Art

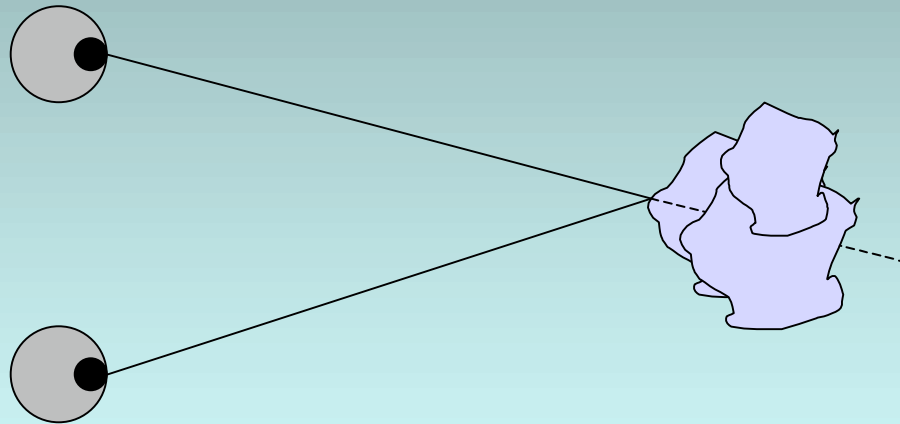

Psychophysical studies (90ies):

Nonoverlapping Objects
(Optical See-Through)

- Perceived object location:
(stereopsis & perspective clues)
 - systematic shift of ~50mm
 - significant variation across subjects
- Perceived object size:
 - seemed smaller than they theoretically were

2.2 Depth Perception:

Perceived Depth of Object Position

Requirements

State of the Art

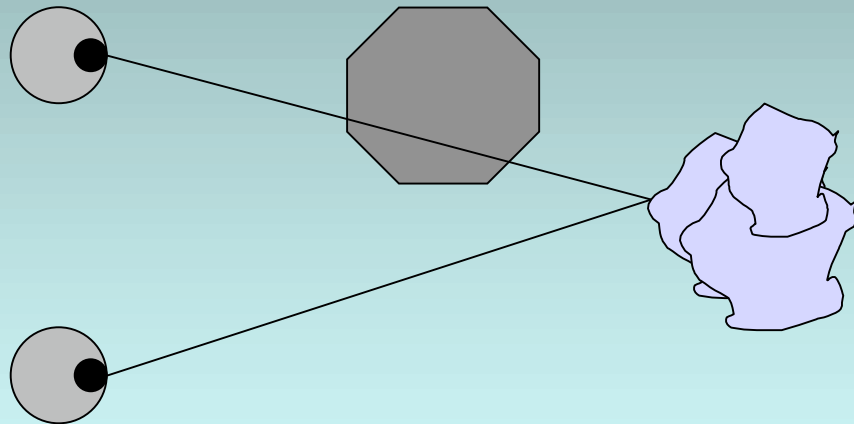

Psychophysical studies (95, 97):

Overlapping Objects (Optical See-Through)

- Perceived object location:
 - real object close to (slightly in front of) virtual object: virtual object appeared closer than planned
 - opaque real object substantially in front of virtual object: real object appeared transparent

2.3 Adaptation

Requirements

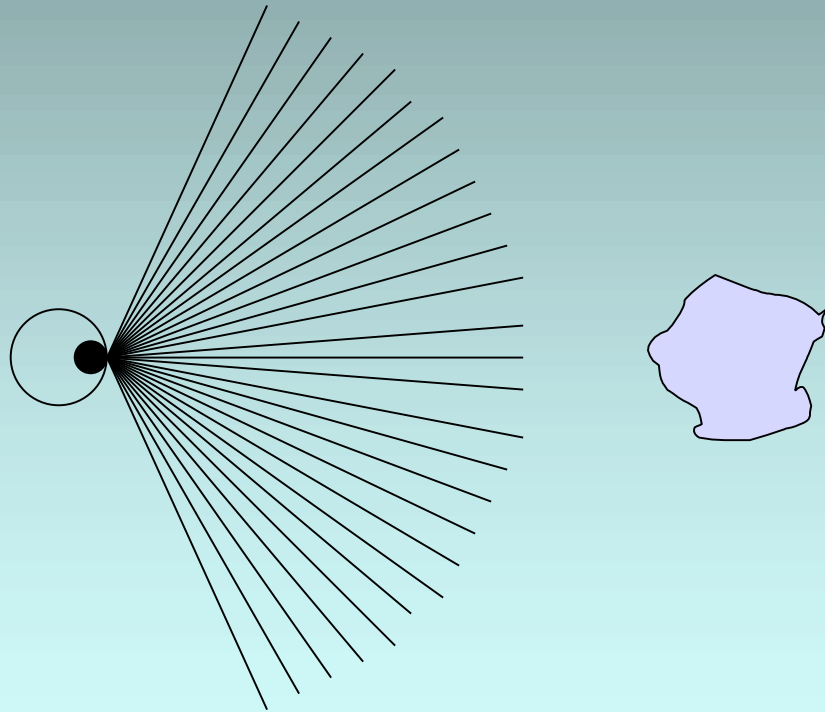

State of the Art

- Adapt. to visual displacement
Large FOV Video See-Through
 - 62 mm higher, 165 mm forward
 - Increasing performance over time
 - Negative aftereffects
 - 1 case of cybersickness
- Implications of aftereffects
 - Recovery period after HMD use
 - Duration?
 - Gradual or dual adaptation?
- Shift in camera eyepoints must be minimized

2.4 Peripheral FOV

Requirements

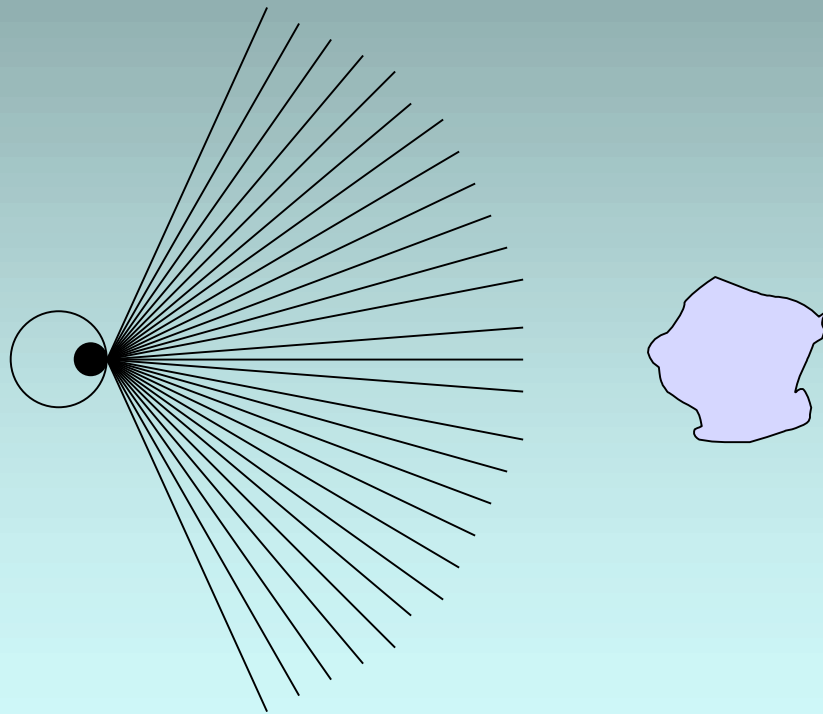

State of the Art

- Optical See-Through HMDs
 - Intuitive
- Video See-Through HMDs
 - User can see around the video area
 - Questions regarding the different presentation style in overlay (video) and peripheral (optical) area:
 - Different accommodation efforts for user!
 - Conflicting cues?
 - Discomfort?

2.5 Depth of Field

Requirements

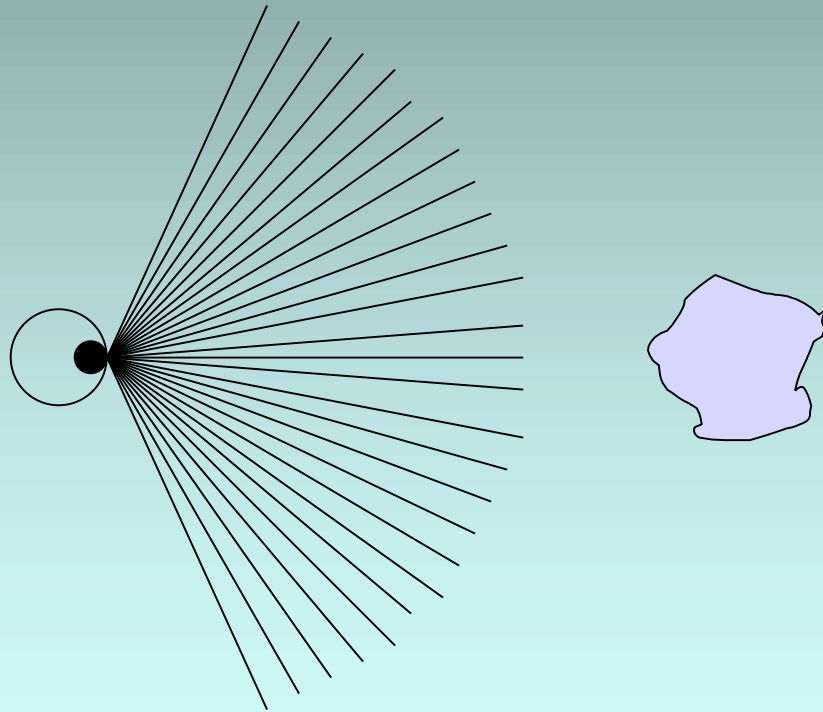

Depth of field: (pupil 2 - 4 mm diameter)

–at 1 m: [0.94 m .. 1.04 m]

–at 17 m: [11 m .. 33 m]

State of the Art

- The larger the depth of field, the smaller the need for accommodation
- Accommodation plays an important role at close working distance
- Video See-Through HMDs
 - Cameras must have depth of field according to current working distance (autofocus?)
- Optical See-Through HMDs
 - User's pupil enlarged due to reduced light --> smaller depth of field
 - Problem: real/virtual objects at different depths

