

VOLKSWAGEN

AKTIENGESELLSCHAFT

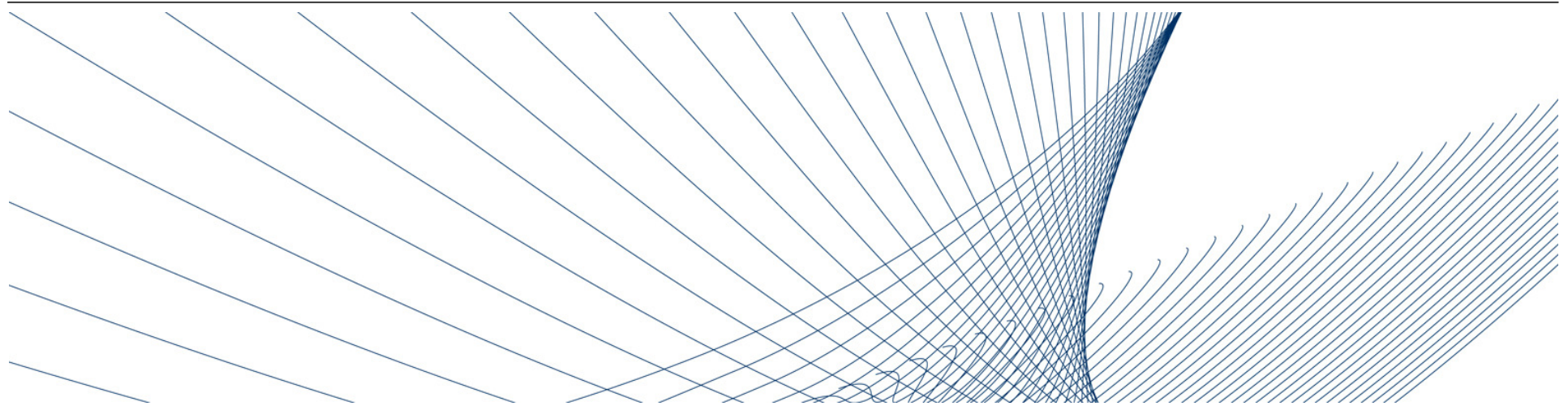

Augmented Reality Applications within Industry

ISMAR

**Workshop on Industrial Augmented Reality: Needs and Solutions,
15. September 2008, Cambridge**

Process

Design

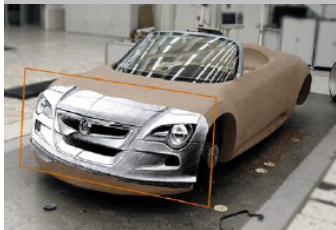

Development



Production Planning

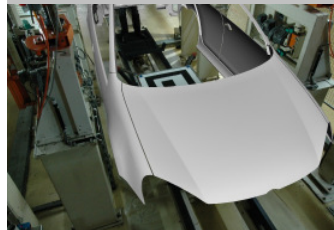

Production



After Sales



Economic Potential Analysis

Question: Influence of the usage of Augmented Reality Technology onto production time and quality

Situation: Simple assembly operation within vehicle assembly

Assembly Tact



Schematic Layout of Assembly

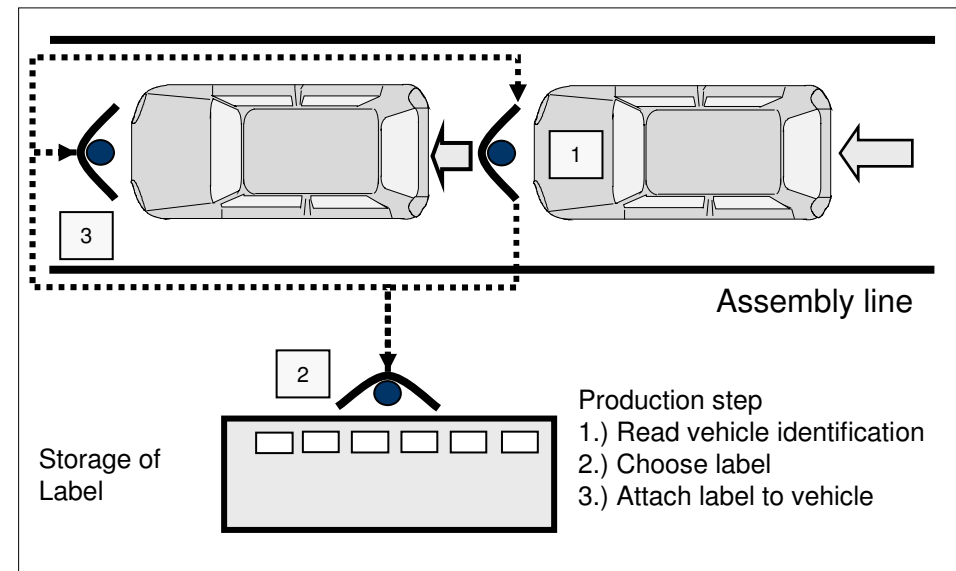

Economic Potential Results

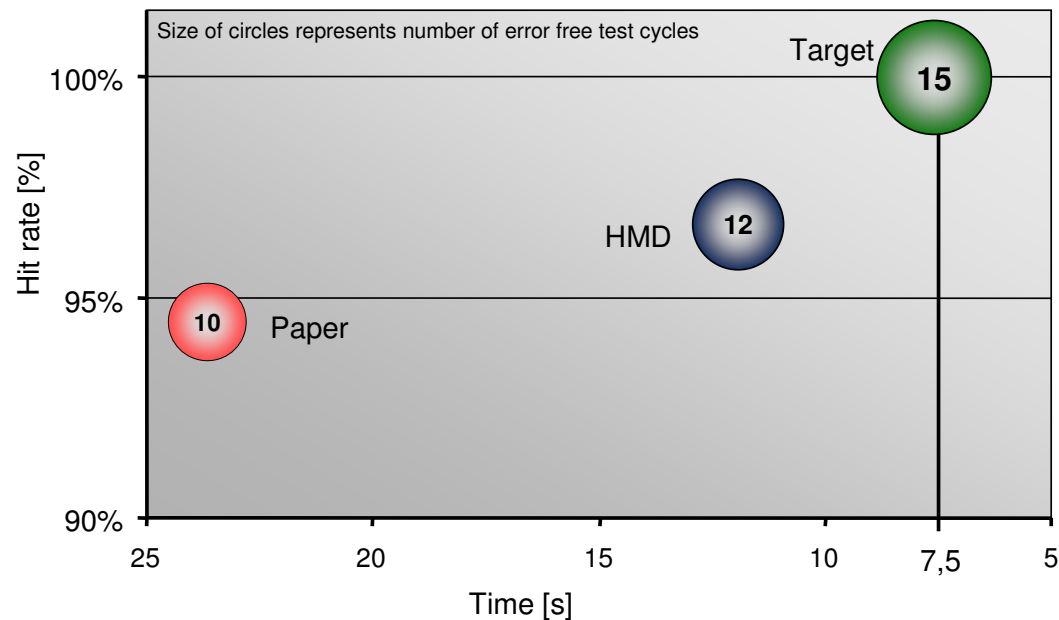

- HMD reached good results
- Paper list reached only medium results
- Used HMS had negative implications on results due to insufficient ergonomic characteristics

Reduction due to

- **Parallelization of information reception and sideline job**
- **Reduction of search effort by displaying the position within HMD**

Variance comparison

Introduction

Planning task

- Align fixture extension by automatic fixture devices with integrated spot welding

Objectives

- Verification of up-to-dateness of existent planning data
- Interfering edge analyses of the new planned welding devices

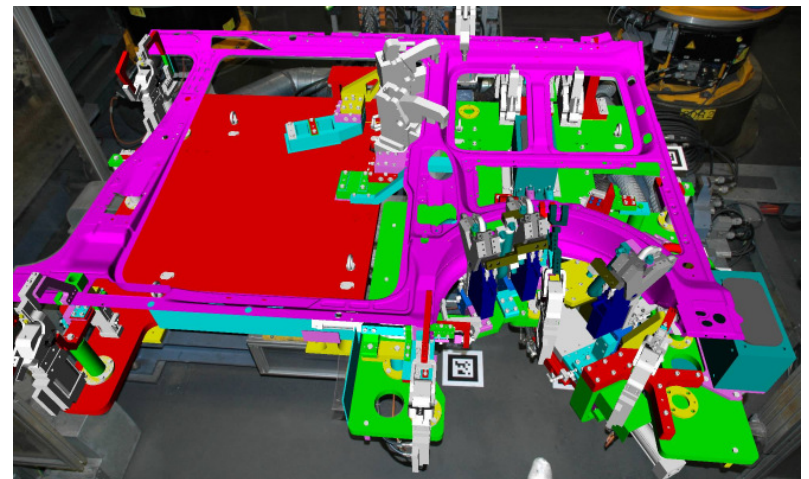
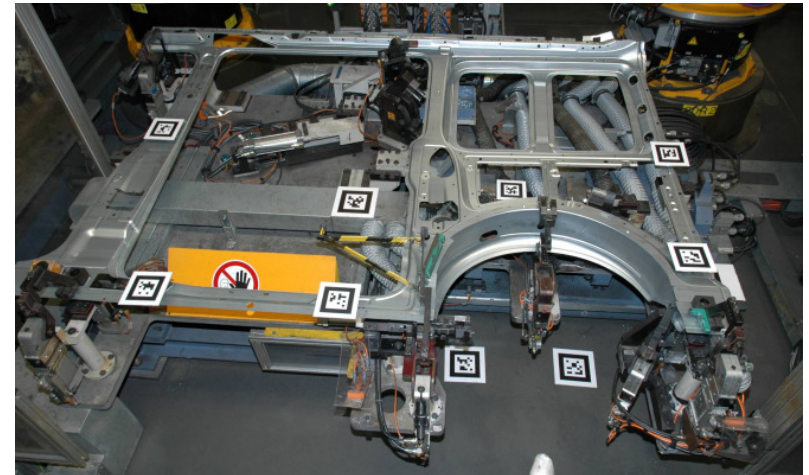

Variance comparison Procedure

Preparation
(0,5h)



Execution
(1,5h)



Evaluation
(1h)

Preparation steps

- In place examination
- Acquisition of CAD data
- Selection of reference points

Workflow

- Marker installation
- Taking the pictures

Evaluation process

- AR-scene creation
- Cooperative evaluation

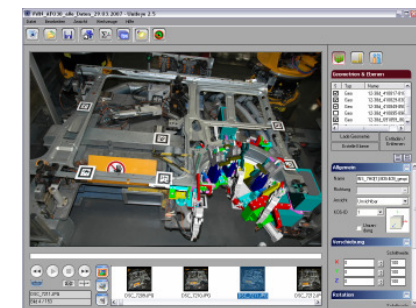
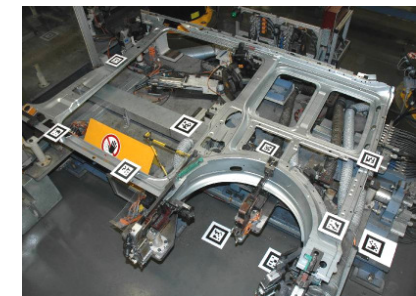
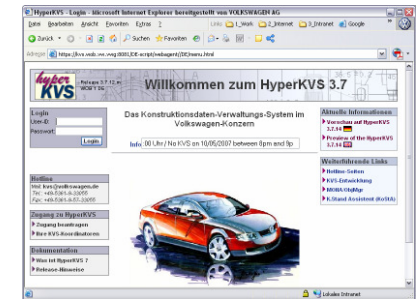

Variance comparison

Preparation, selection of reference points

Preparation
(0,5h)



Execution
(1,5h)



Evaluation
(1h)

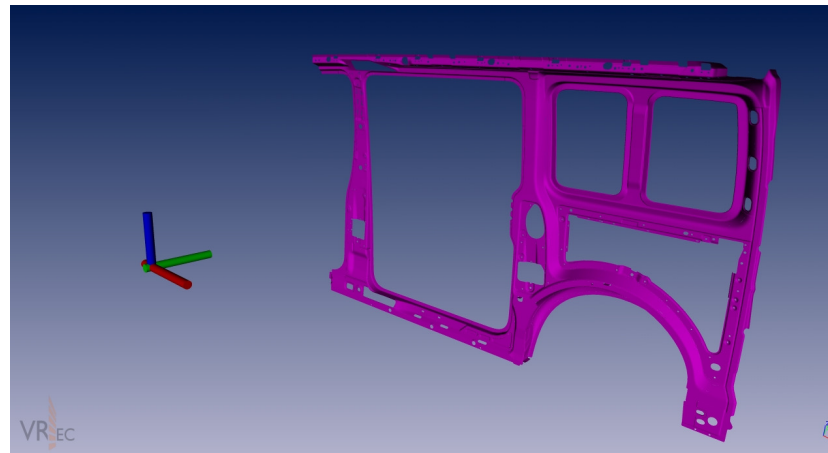

→ reference points in world coordinate system

→ reference points in marker coordinate system

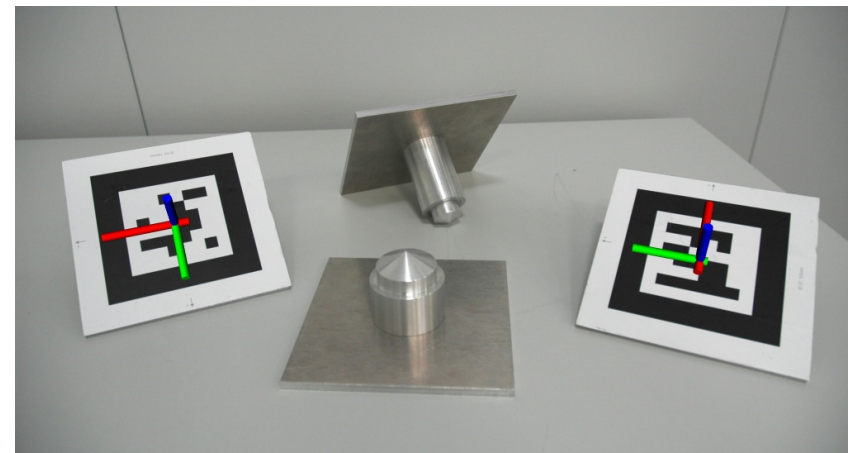

Variance comparison Marker installation

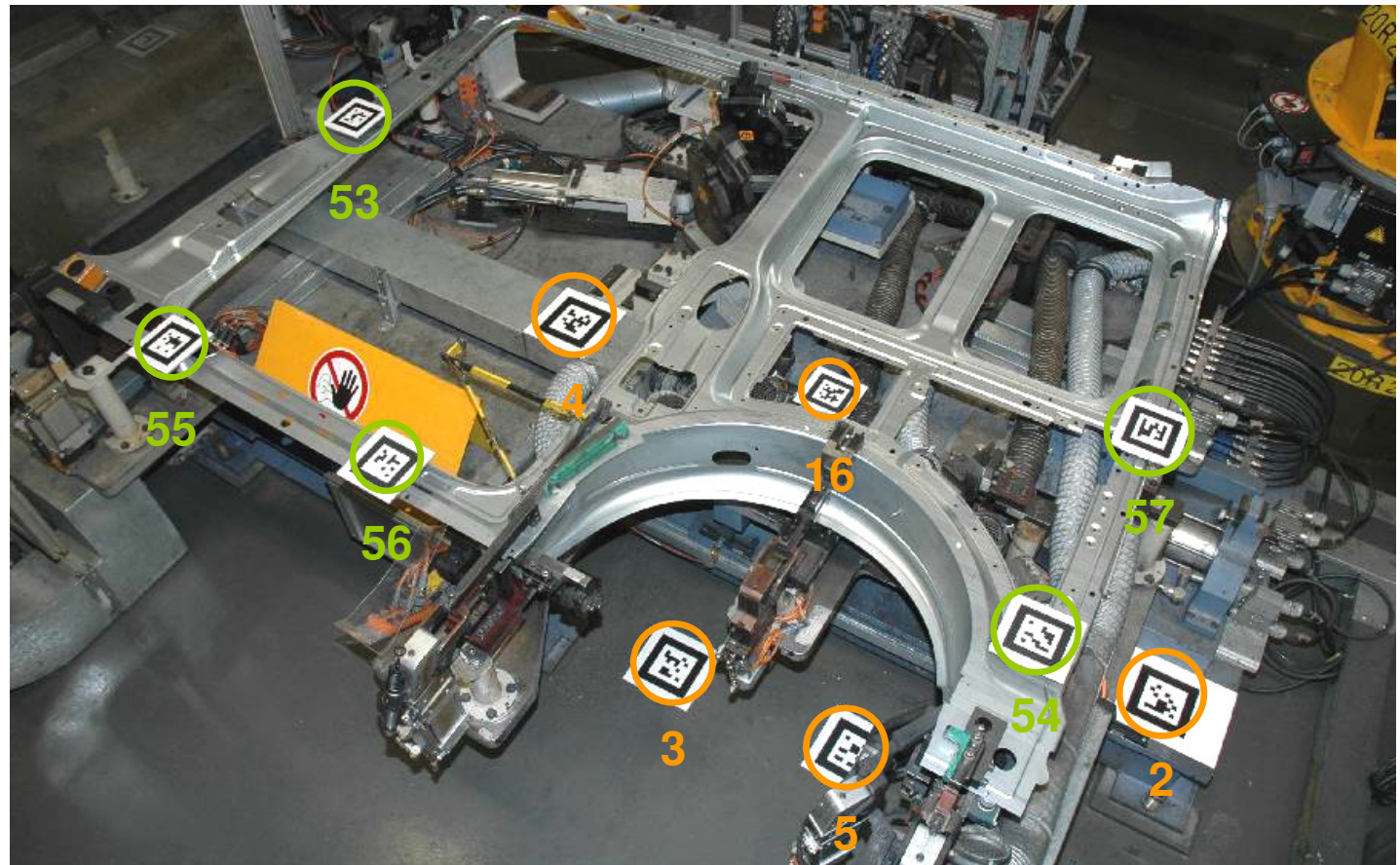
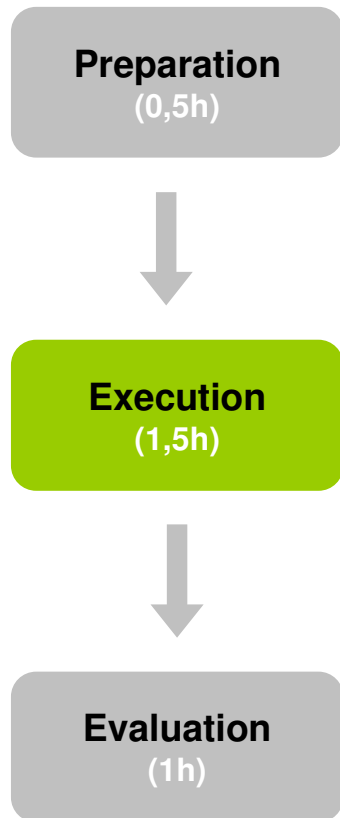

→ reference marker (body part) → additional markers (align fixture)

Variance comparison

Taking the pictures

Preparation
(0,5h)



Execution
(1,5h)



Evaluation
(1h)

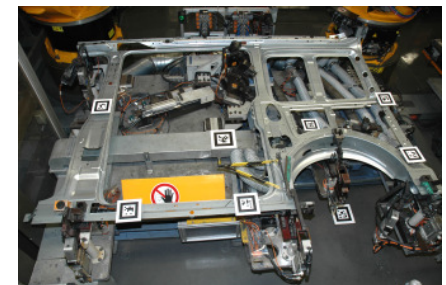
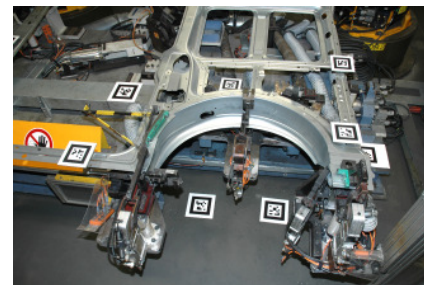
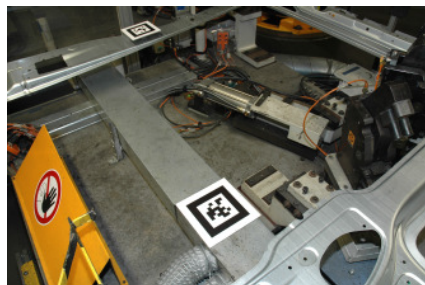
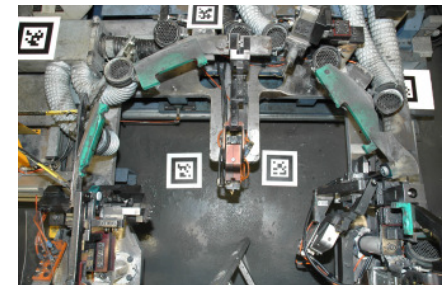
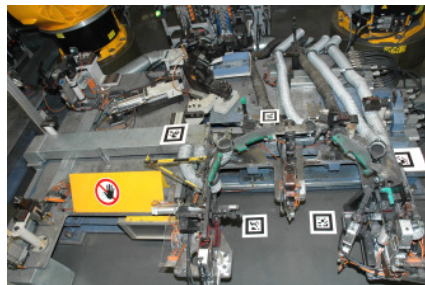
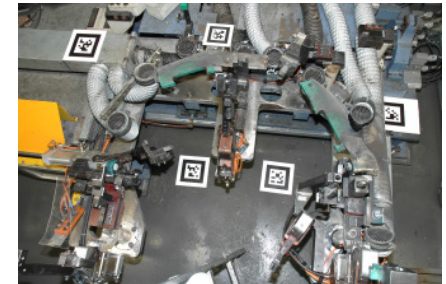
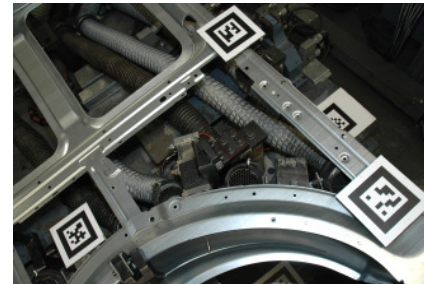

Variance comparison Evaluation with metaio Roivis software

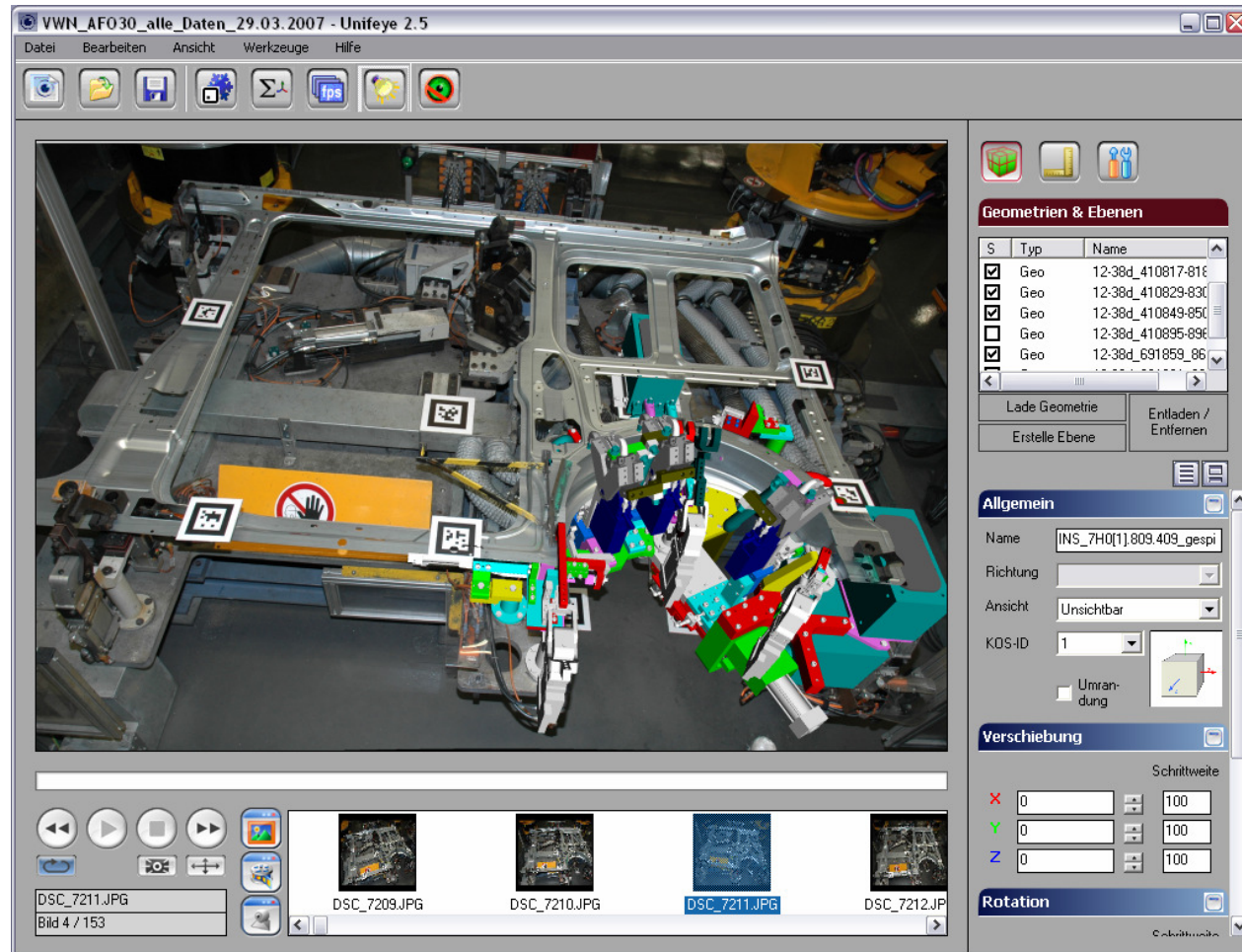
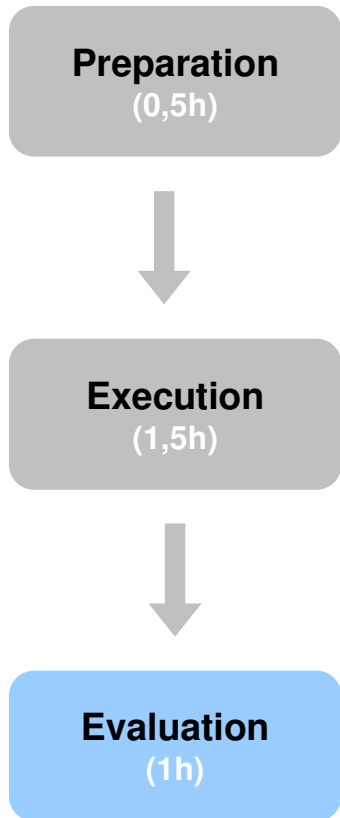

Variance comparison Evaluation - welding clamp (middle, new)

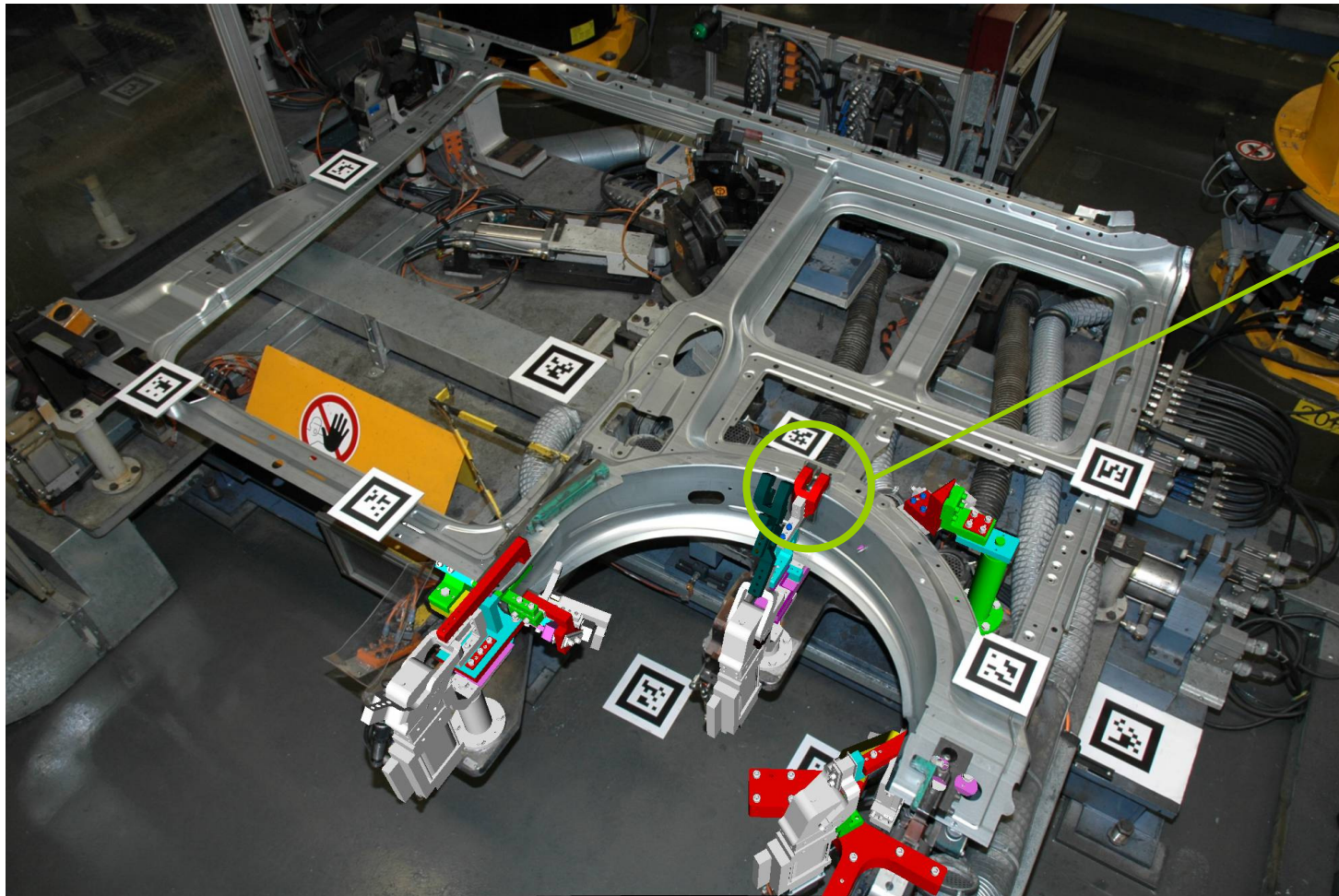

CAD-clamp
matches with the reality

Variance comparison Evaluation - welding clamp (middle, new)

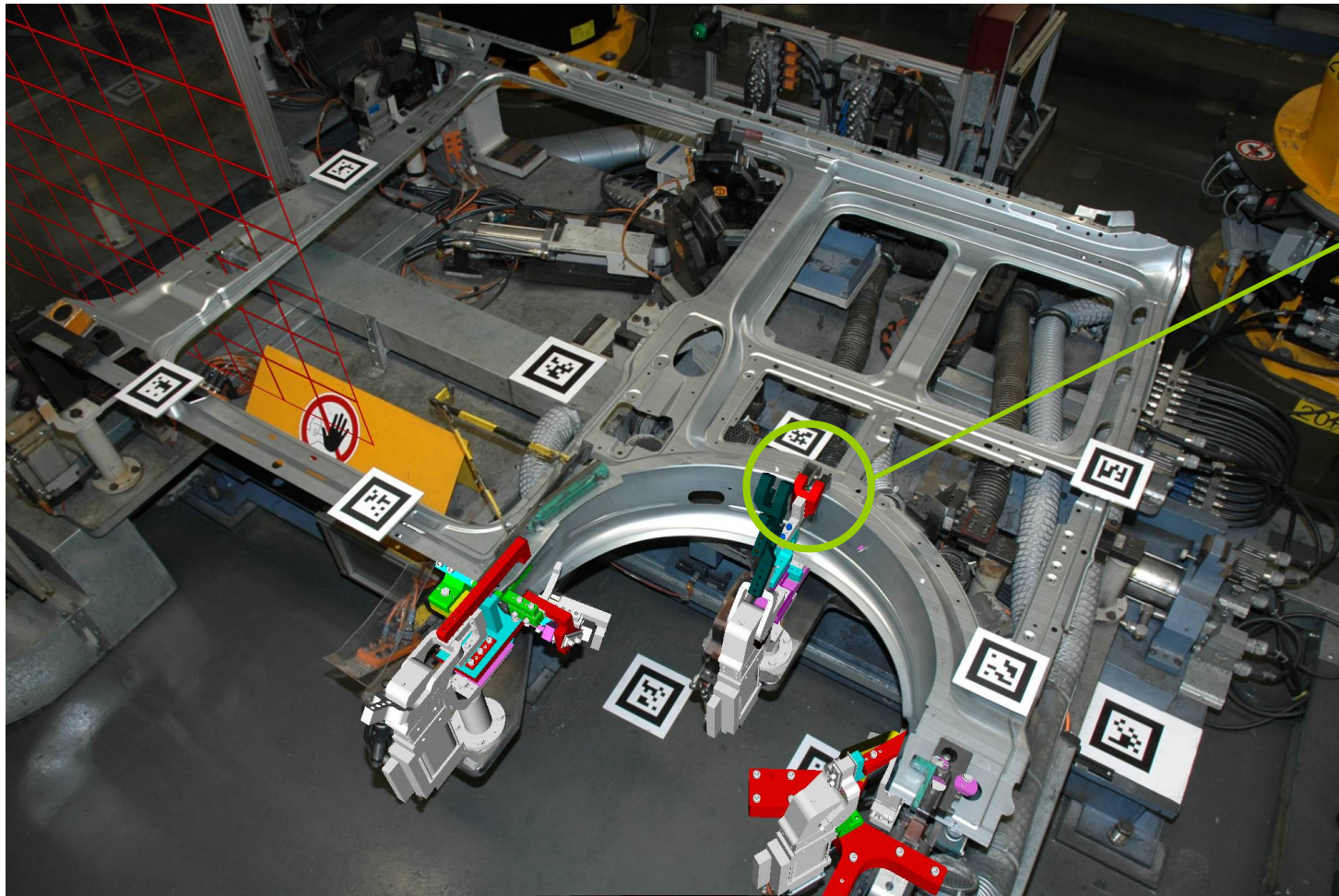

CAD-clamp
matches with the reality

Variance comparison Evaluation - welding clamp (middle, new)

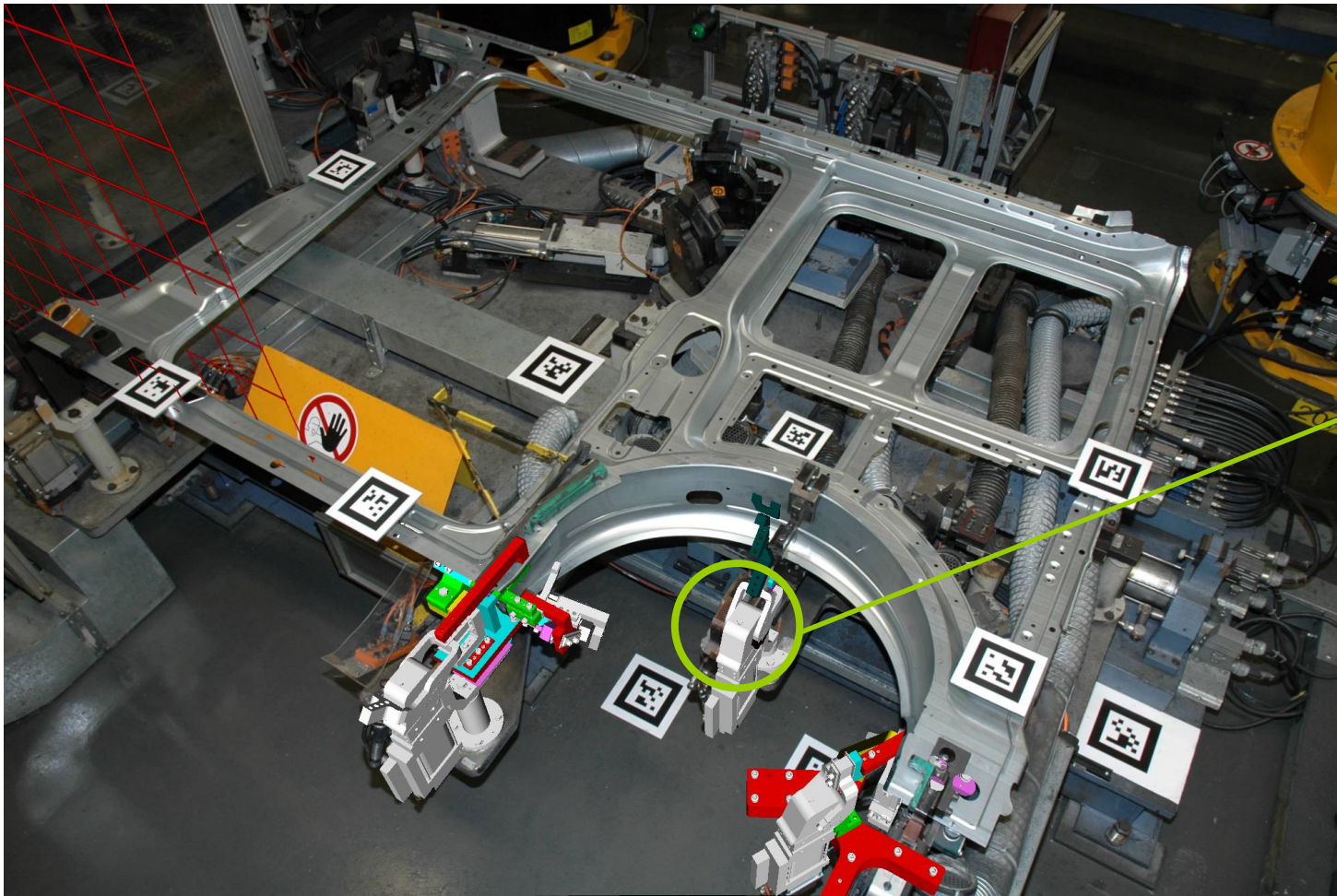

CAD-clamp does not
comply with the reality

Variance comparison Evaluation - welding clamp (middle, new)

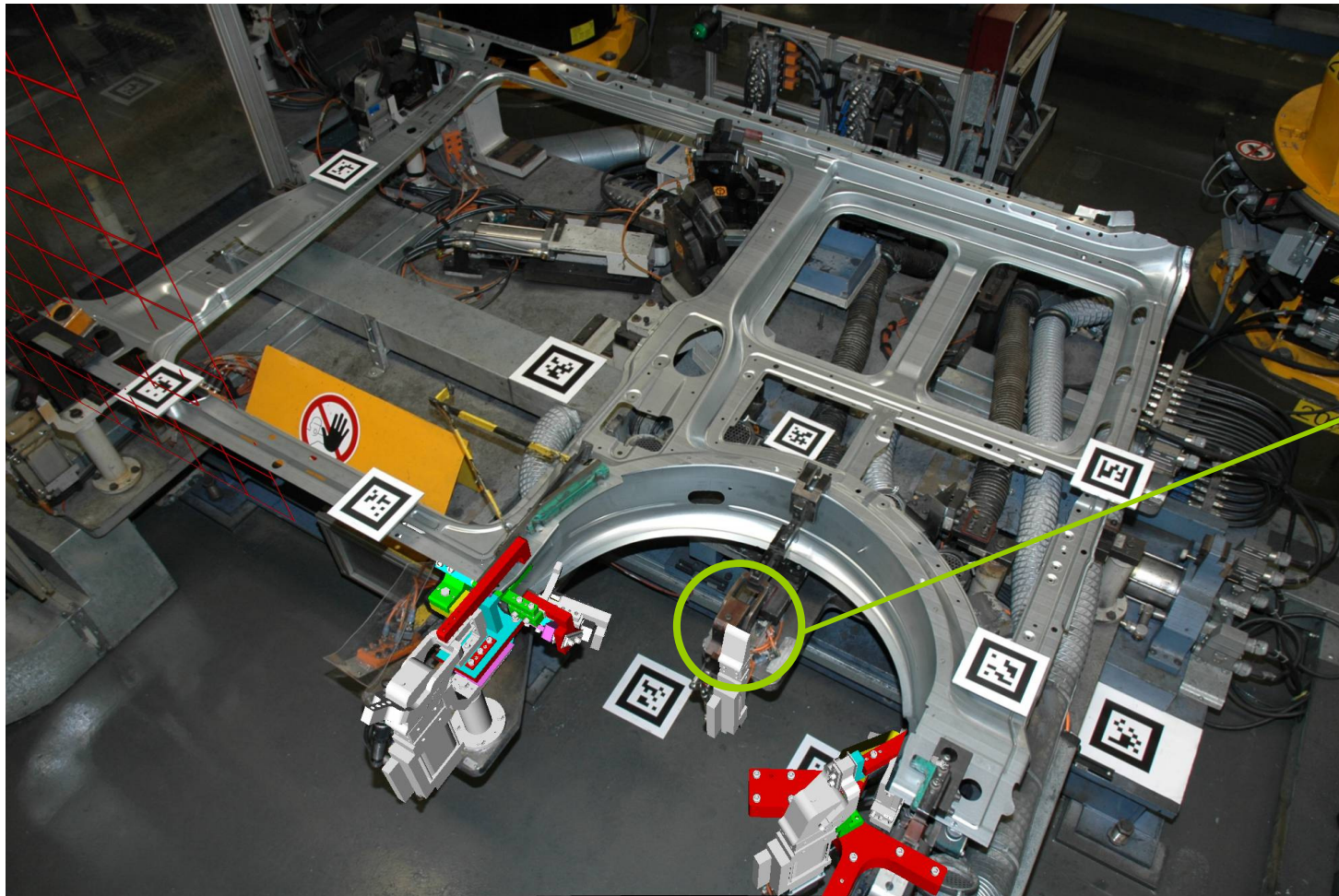

CAD-clamp does not
comply with the reality

Variance comparison

Findings / Outcome

Benefits

- Planning reliability increased by 18% onto 98% (80% without Augmented Reality)
 - Reduction of costs during the installation process (not quantifiable)
 - Installation / assembly on schedule, no in-place optimization required
- Construction costs reduced by ca. 8%
 - No need for manual as-is analysis by construction engineer

Conclusion

- The use of Augmented Reality in the scope of plant modification is absolutely reasonable.
- Costs for installation and modification can be decreased, by avoiding downstream optimization efforts. Construction reliability is up to 98%.
- The task of Augmented Reality analysis should be conducted by construction service providers and is thus to include in the manufacturers specification sheet.
- Additional Projects are planned and will be realized in near future.

Stud Welding System Faro Measurement Arm

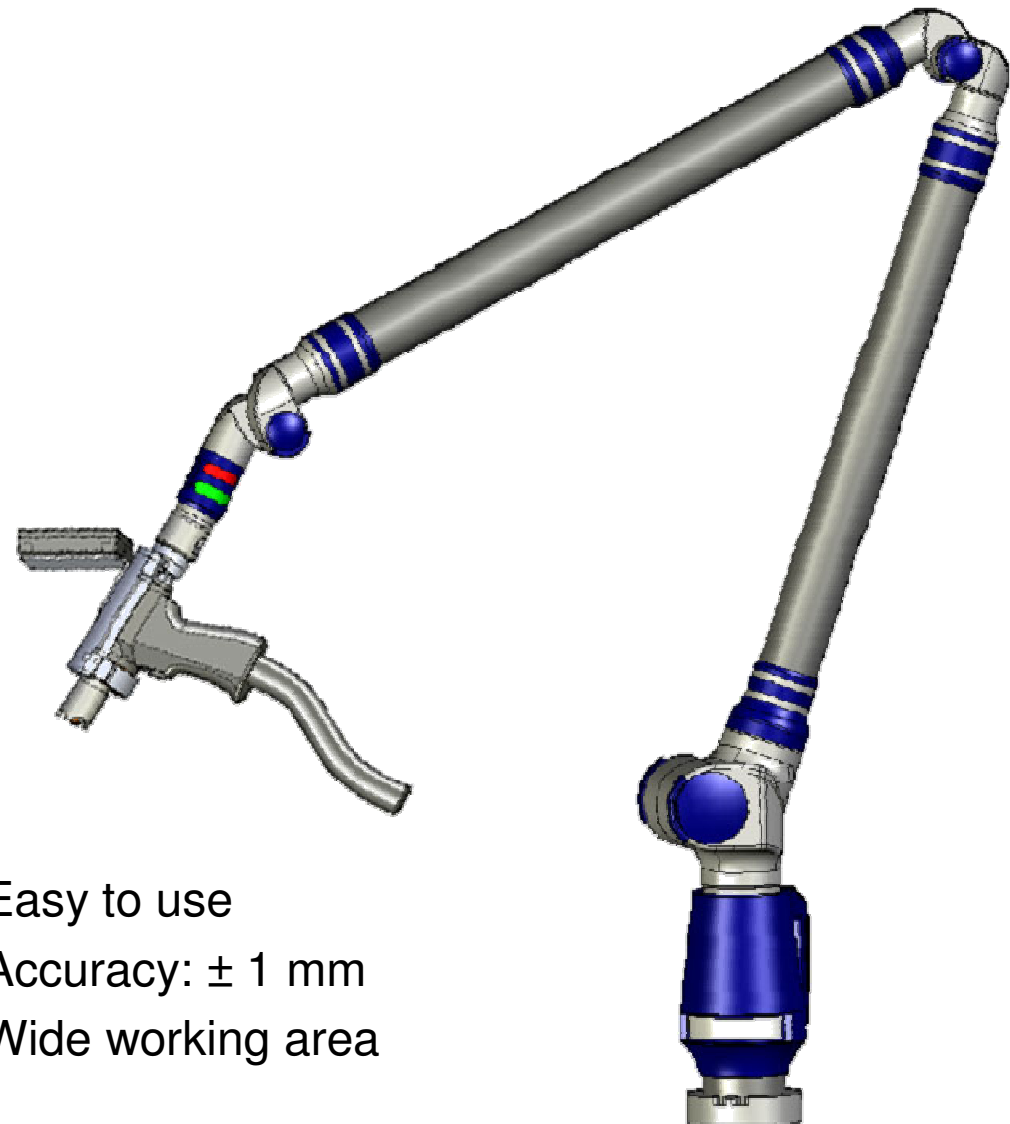

- Easy to use
- Accuracy: ± 1 mm
- Wide working area

Stud Welding

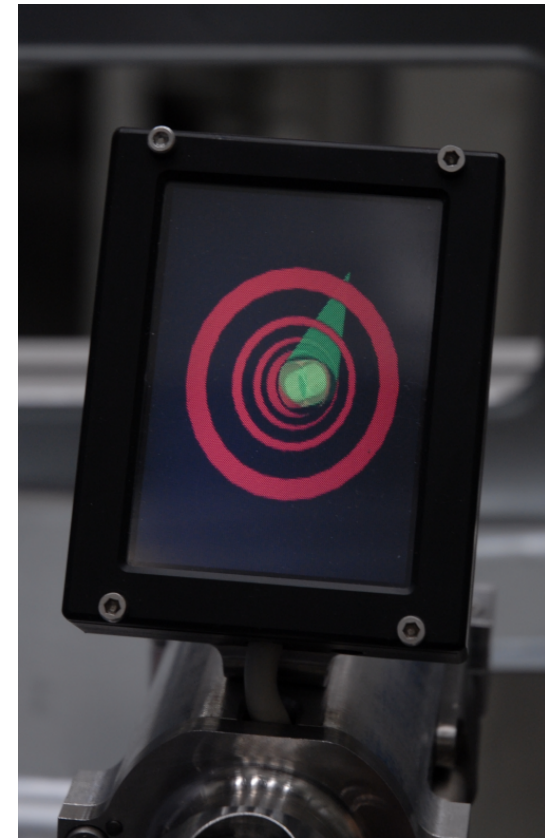
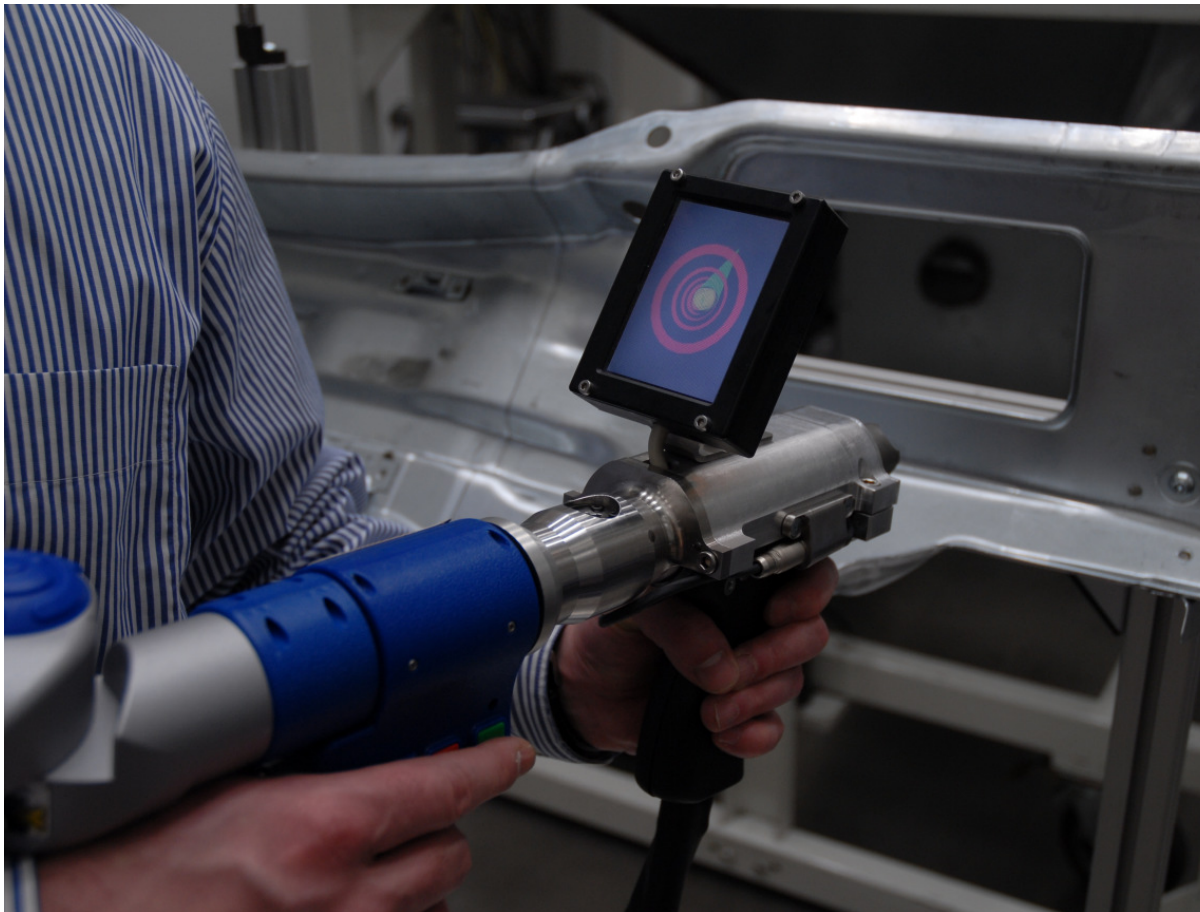

General Requirements of the Industry

- KISS - keep it short & simple!
- Intuitive handling without special Virtual Technology know-how
- Standard system
- Universal system
- Usable for different application in different areas of the industrial process
- Preparation time max 30 minutes
- Economic system

