

Dealing with Complexity in Industrial Tracking Environments

Peter Keitler

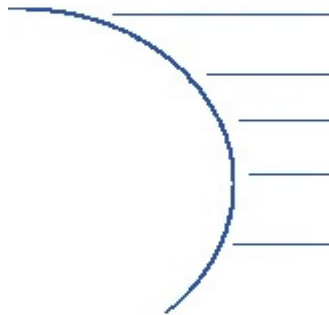
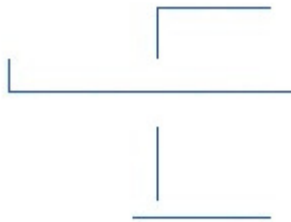

	track
	frame

- Tracking setups tend to become more and more complex...
 - Ubitrack middleware
 - Separates applications from tracking
 - Many sensors / algorithms out-of-the-box
 - AR applications...
 - ...don't know any longer about sensors
 - ...thus cannot be responsible for registration problems
- => Need for generic tools on middleware layer
- Setup
 - Registration
 - Runtime

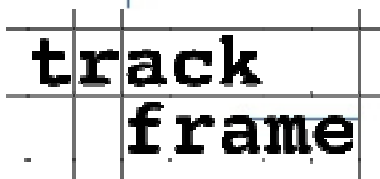
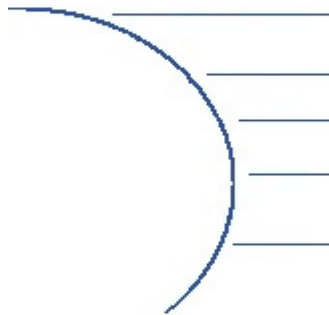
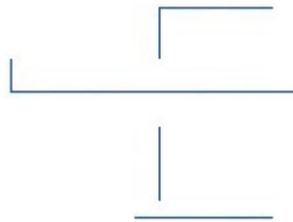

1. Calibration and registration

- 1. General types
- 2. Generic implementation in trackman
- 3. Abstraction by meta-patterns

2. Tools for more robustness and tracking quality

1. Planning/setup: Monte-Carlo simulation

2. Registration phase: Observe...

- ✓ ...availability of tracking data
- ✓ ...algorithm convergence

3. Runtime: Plausibility checks

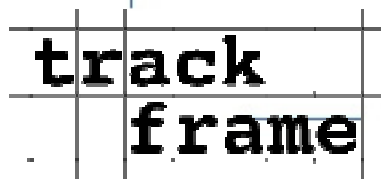
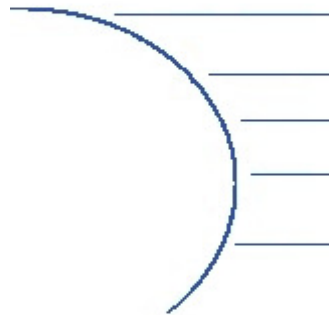
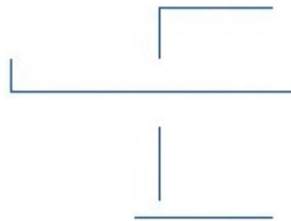

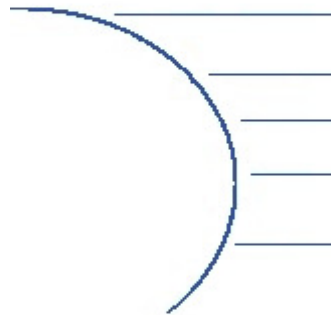
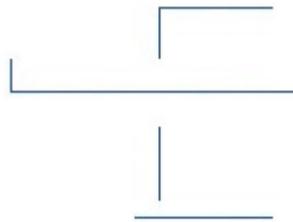

track
frame

- Important algorithms for AR
 - 3D-3D pose estimation (absolute orientation)
 - Hand-eye calibration
 - Tip calibration
 - HMD calibration (SPAAM)
- Measurement data
 - Points, orientations, poses
 - Correspondences
- General treatment possible?
 - Continuous measurements vs. user-triggered measurements
 - Simultaneous vs. sequential measurement of correspondences

Tip Calibration

Single source of continuous measurements

→ One-step approach

→ No synchronization needed

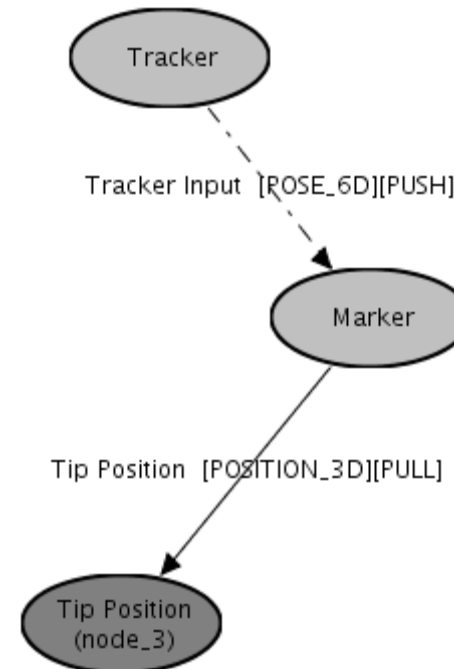
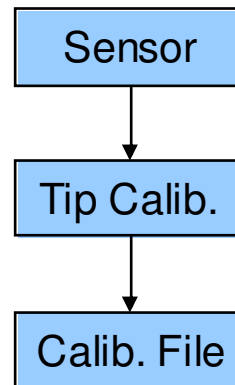
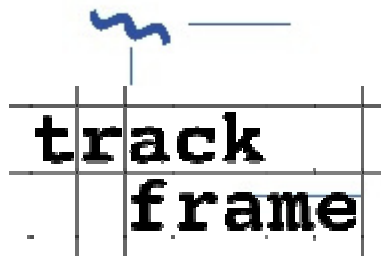
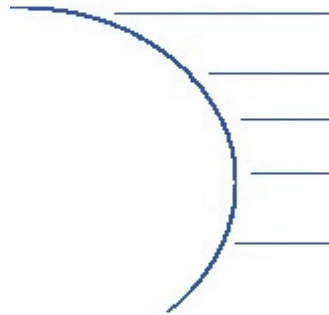
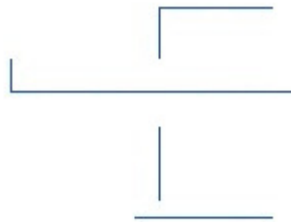

Hand-Eye Calibration

- Two sources of continuous measurements
 - One-step approach
 - Synchronization needed
- Hand-Eye calibration in indirect tracking (demo!)

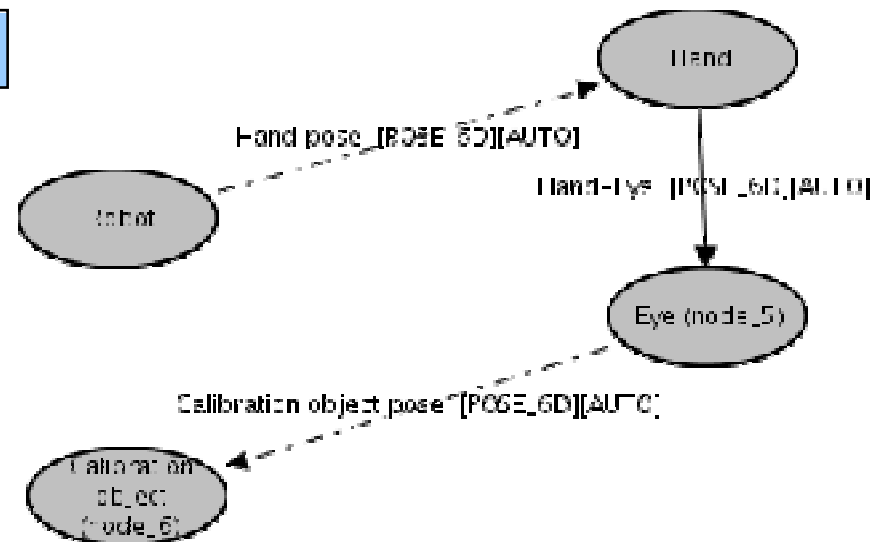
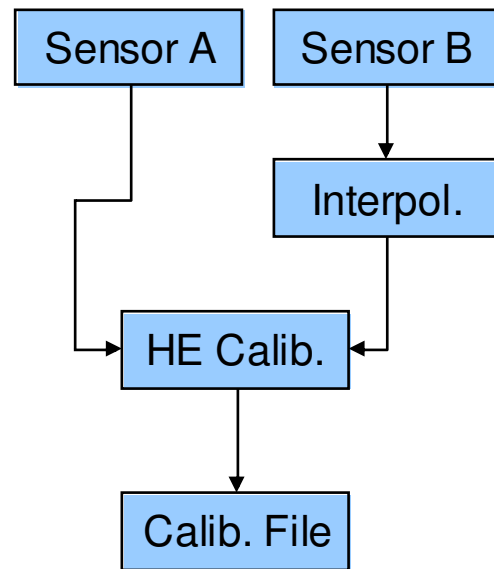
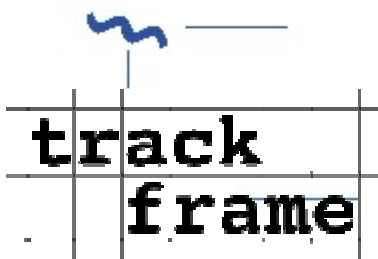
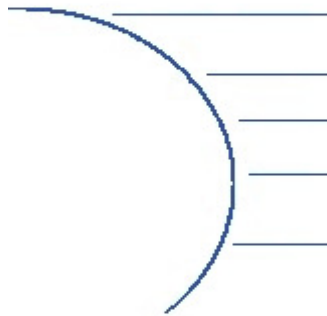
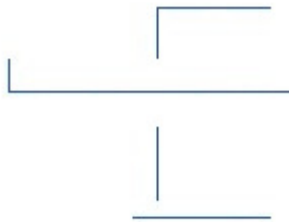

Absolute Orientation

- Two-step approach (sequential measurements)
- User-triggered measurements
- Absolute Orientation Faro – A.R.T. in indirect tracking (demo!)

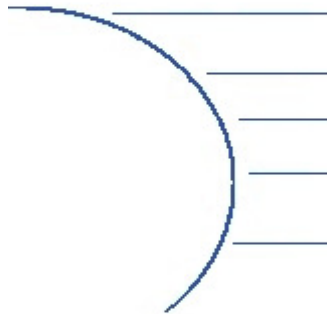
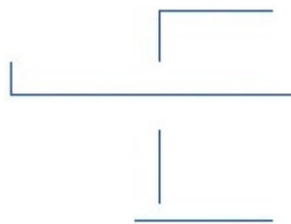

track
frame

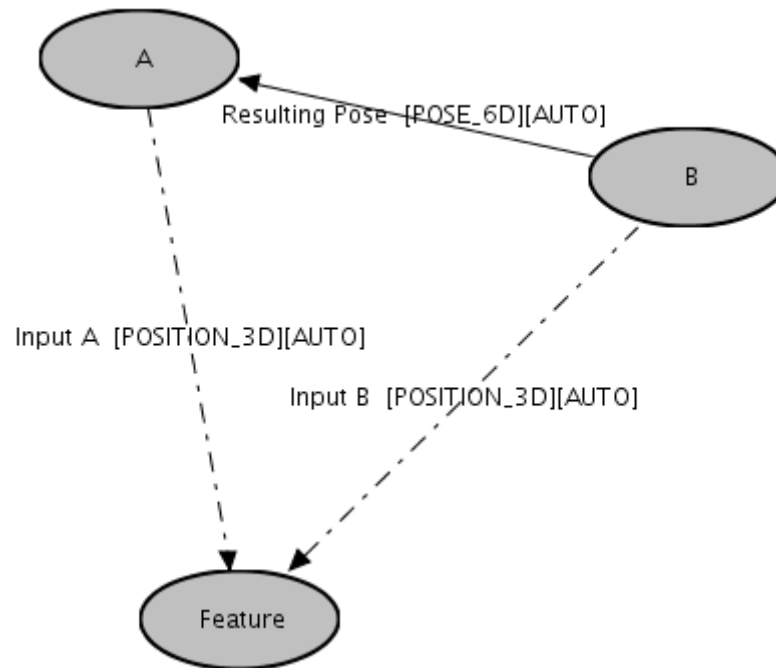

Absolute Orientation

- Two-step approach (sequential measurements)
- User-triggered measurements
- Absolute Orientation Faro – A.R.T. in indirect tracking (demo!)

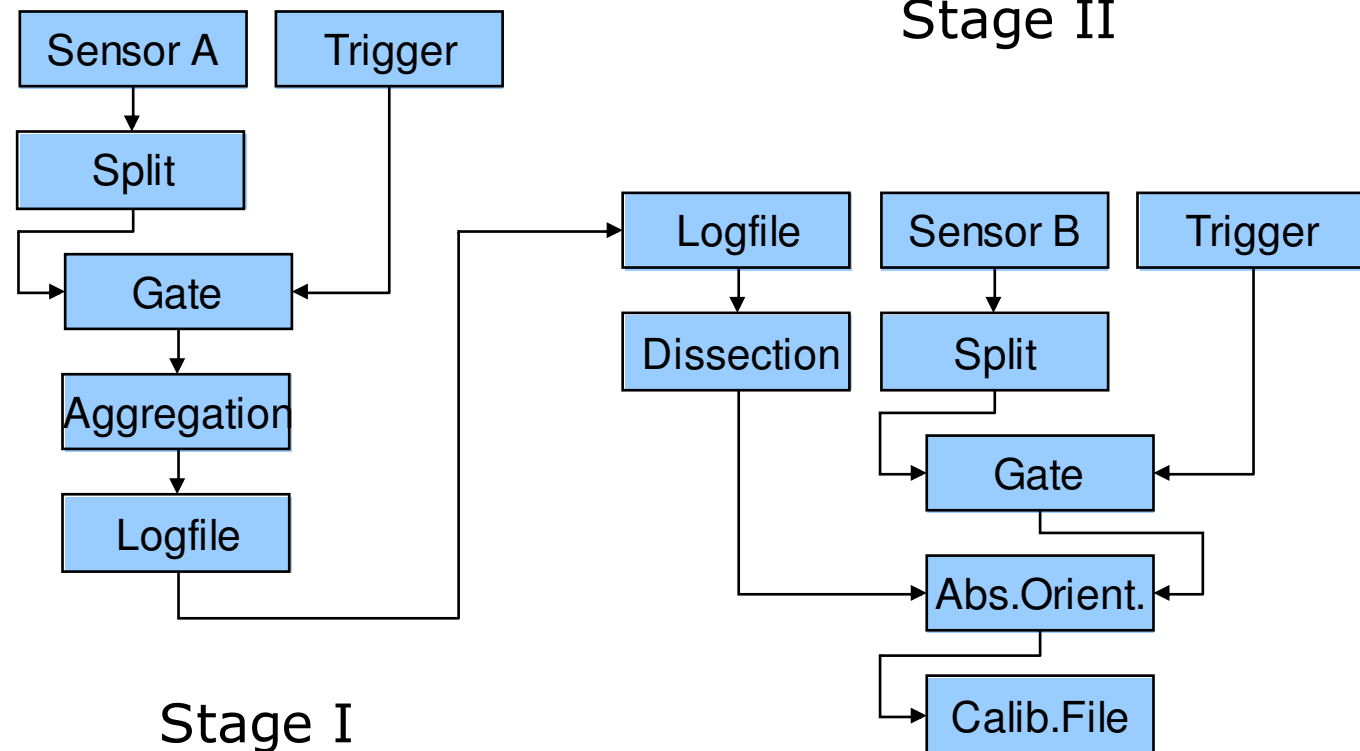
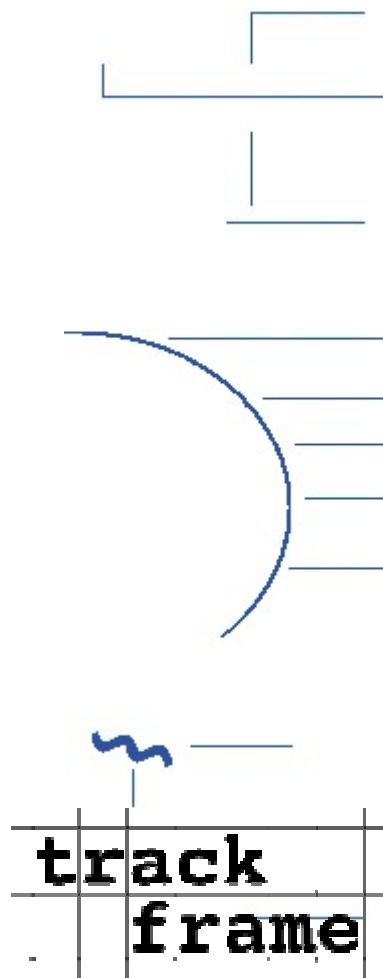

Absolute Orientation

- Two-step approach (sequential measurements)
- User-triggered measurements
- Absolute Orientation Faro – A.R.T. in indirect tracking (demo!)

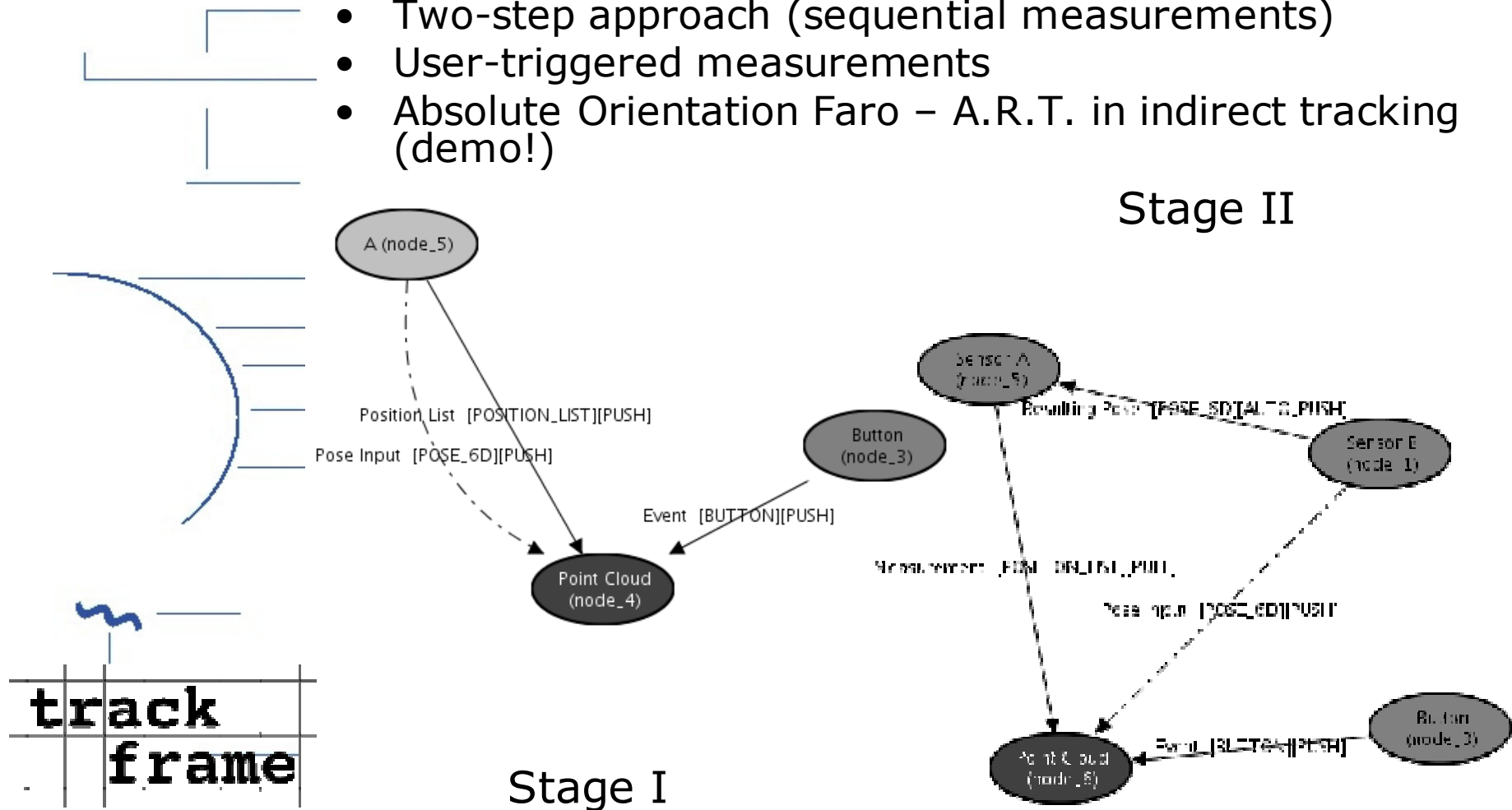

Summary of Registration Types in our Demos

- Odometric tracking
- Indirect tracking

	User-triggered	Immediate	Continuous
1 Sensor	<ul style="list-style-type: none"> • Camera calibration • Absolute Orientation (Stage 1) (3) • Absolute Orientation (Stage 2) (1) 		
2 Sensors	<ul style="list-style-type: none"> • Hand-Eye (2) 		<ul style="list-style-type: none"> • Hand-Eye (Rot. only)
Sensor / Static List	<ul style="list-style-type: none"> • Absolute Orientation (2) 		
Logs		<ul style="list-style-type: none"> • Absolute Orientation (Stage 2) (2) 	

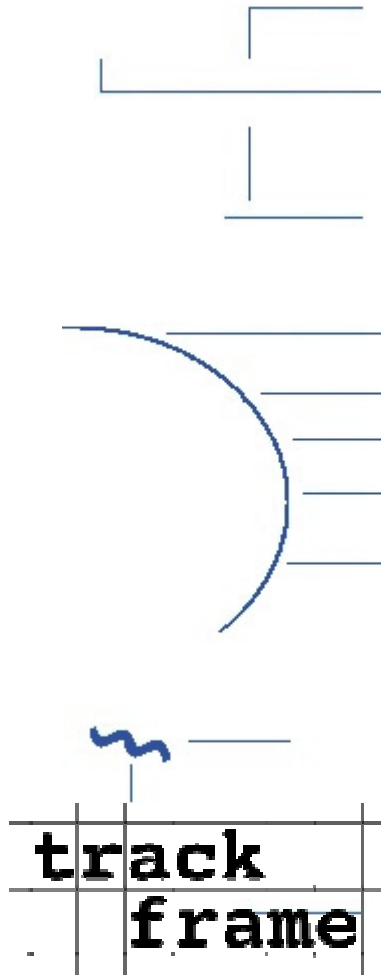

Workflow in trackman

- Add meta pattern to SRG
- Integrate with sensor pattern(s)
- Adapt parameters
- Instantiate dataflow

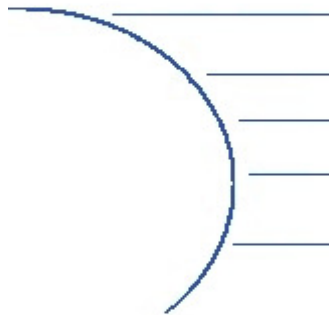
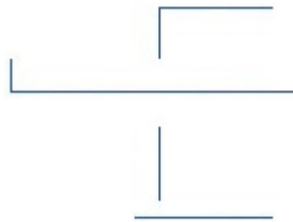

track
frame

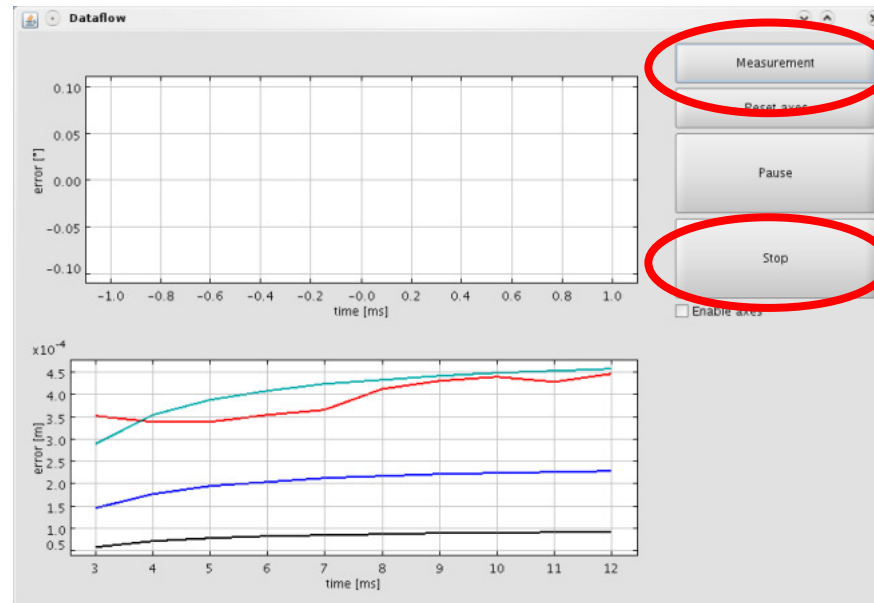

1. Calibration and registration

1. General types
2. Generic implementation in trackman
3. Abstraction by meta-patterns

2. Tools for more robustness and tracking quality

1. Planning/setup: Monte-Carlo simulation

2. Registration phase: Observe...

- ✓ ...availability of tracking data
- ✓ ...algorithm convergence

3. Runtime: Plausibility checks

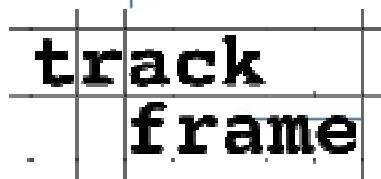
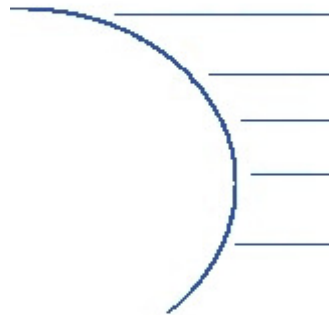
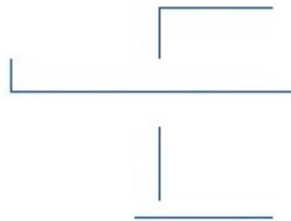

Monte-Carlo Simulation: Overview

- **Goal:** Estimate accuracy of the result of a setup based on the accuracy of the input data
- Functional principle:
 - Input data (ground-truth):
 - ✓ Measurements
 - ✓ Assumed setup
 - Perturb input data using assumed / known PDF
 - Run algorithm many times
 - Obtain PDF of result
- **Problem:** Noise in registration results in **systematic error** during runtime.

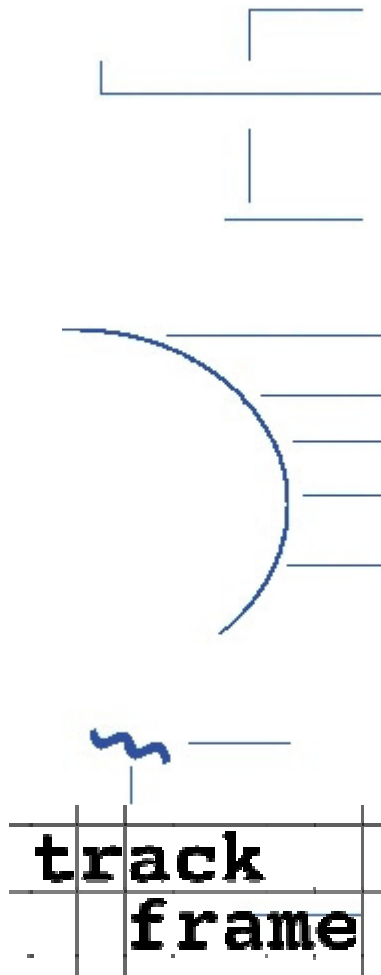

Monte-Carlo Simulation in Ubitrack

- Ground-truth data:
 - Synthetic list of measurements (e.g. corners of a cube)
 - Log of movement in real environment
- Perturbation: Add gaussian noise to points, orientations or poses
- Algorithm (any SRG!)
- Obtain covariance matrix of result

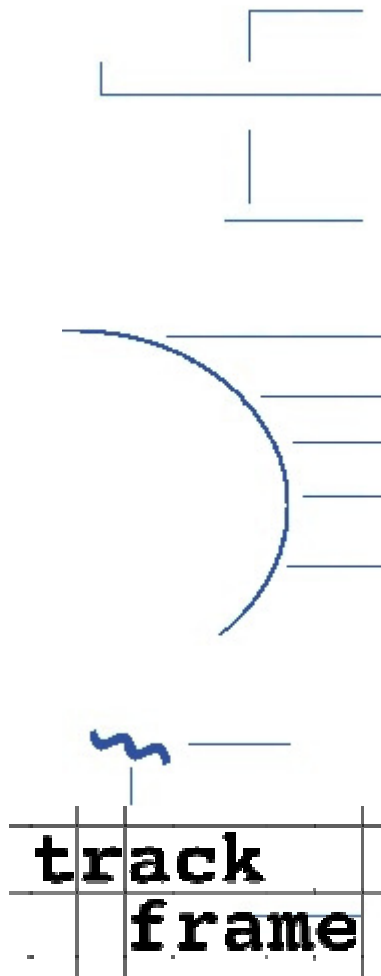
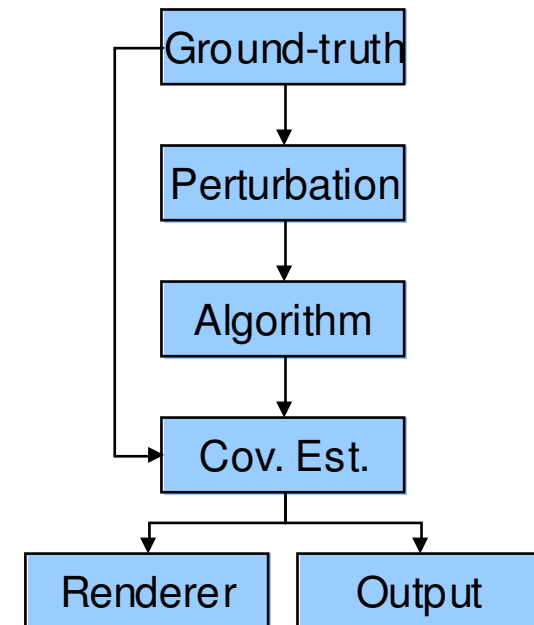

Example

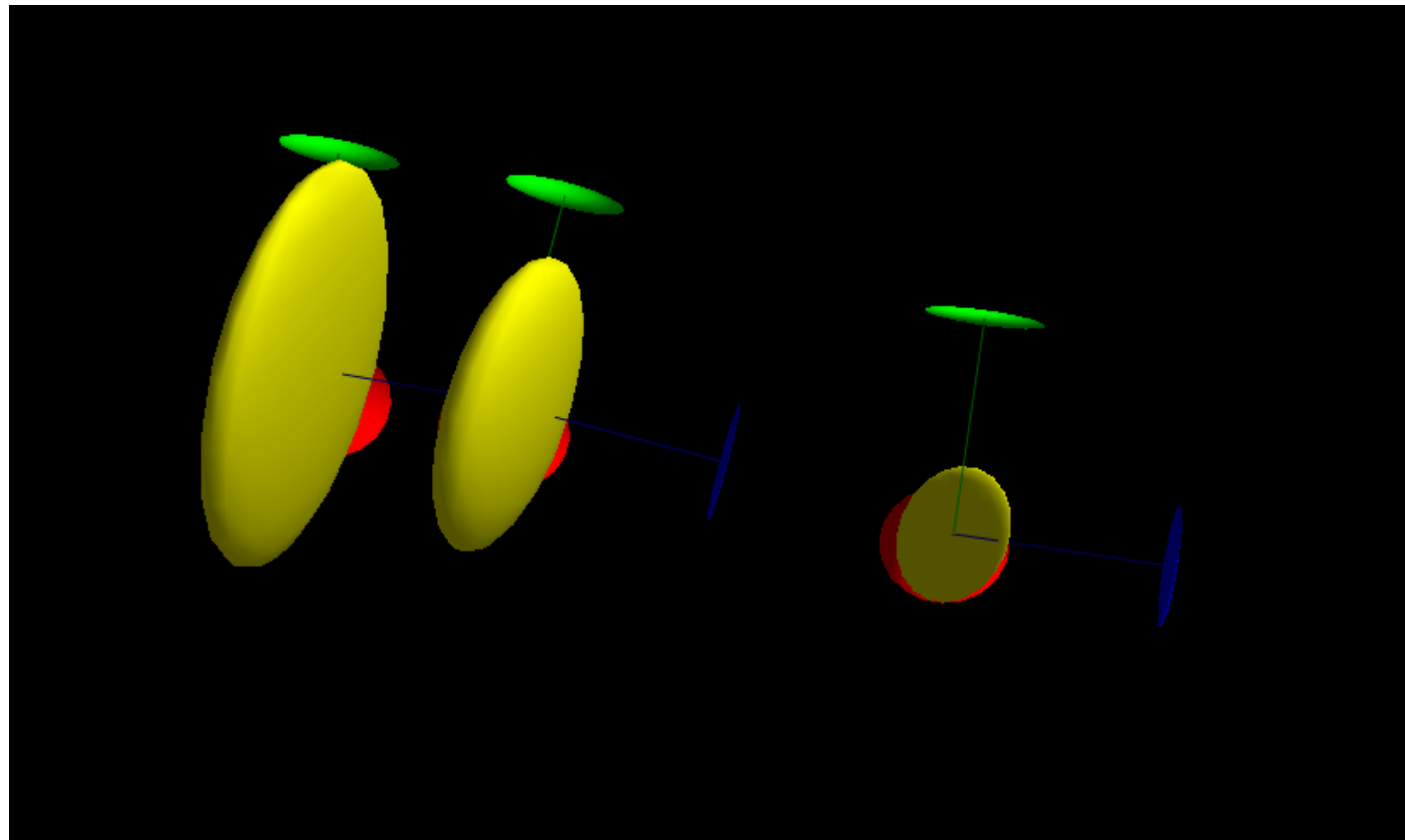
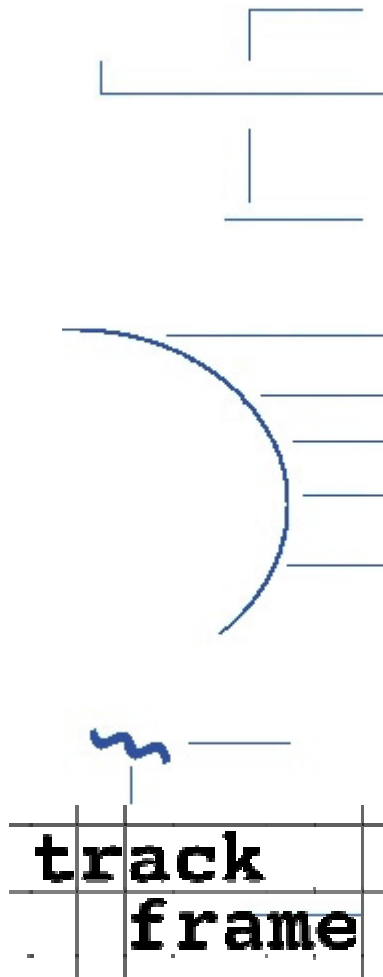

Availability of Tracking Data

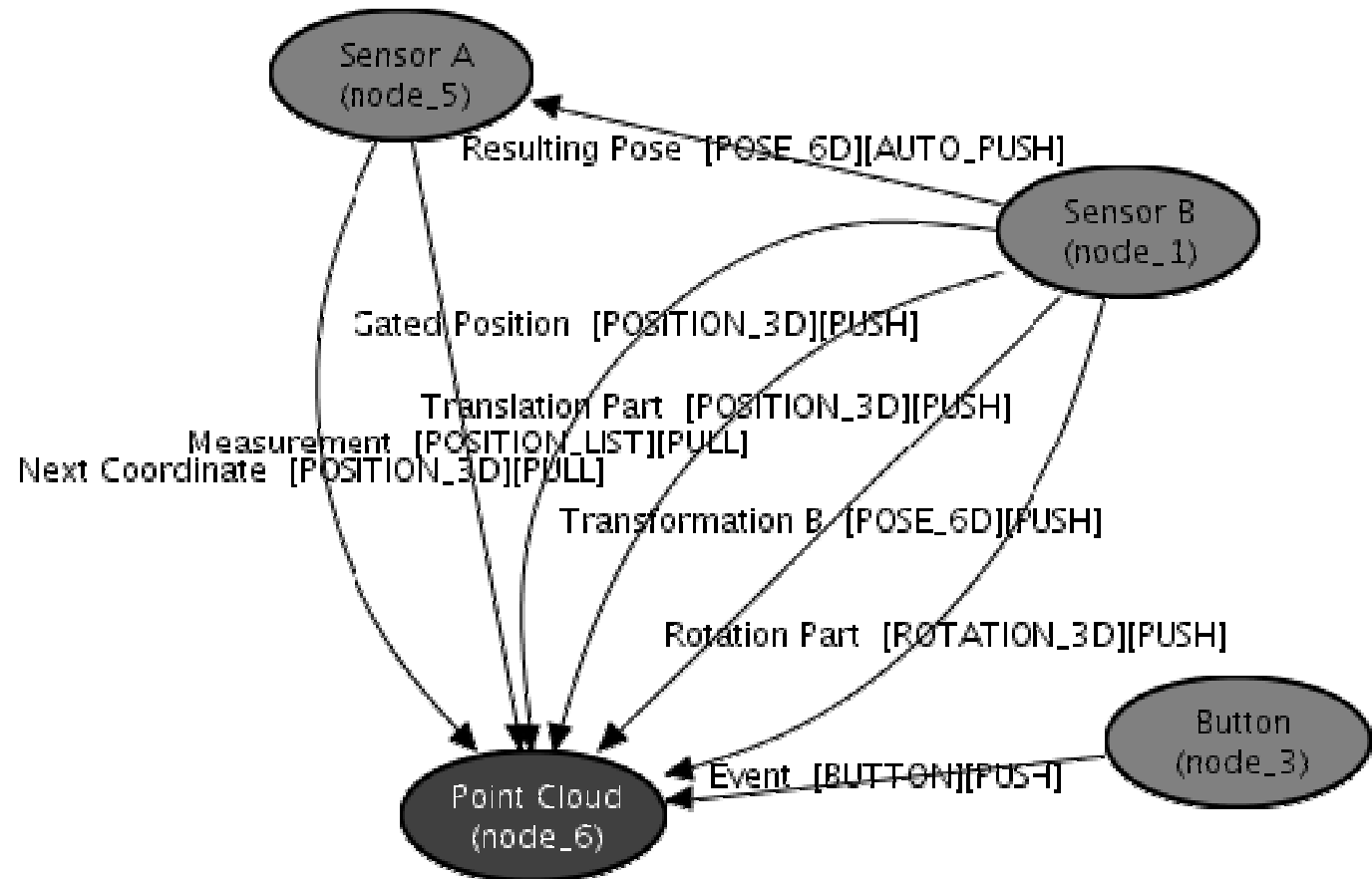
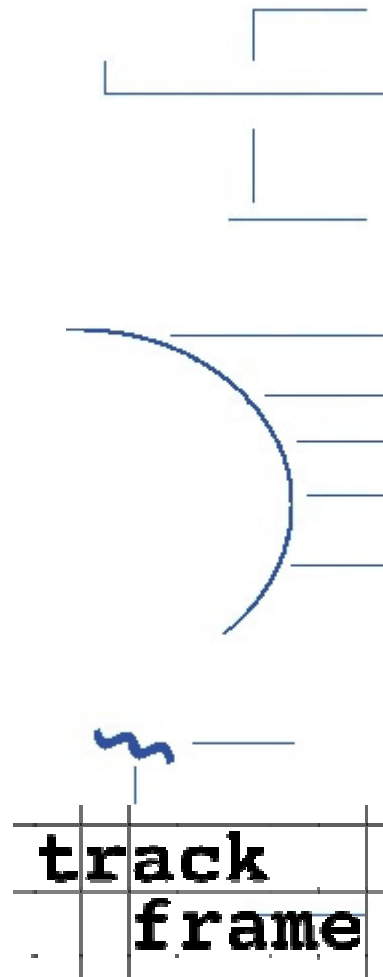

Algorithmic Convergence: Overview

- Mapping $f(P) \rightarrow X$
- Assuming MLE:

$$\epsilon_{res} = \left[\left\| \hat{X} - X \right\|^2 / N \right]^{\frac{1}{2}} = \sigma(1 - d/N)^{\frac{1}{2}} \quad \epsilon_{est} = E \left[\left\| \hat{X} - \bar{X} \right\|^2 \right]^{\frac{1}{2}} = \sigma(d/N)^{\frac{1}{2}}$$

- Example: 3D-3D Pose Estimation
 - Error in second frame only: 6 DoF
 - Error in both frames: $3n+6$ DoF

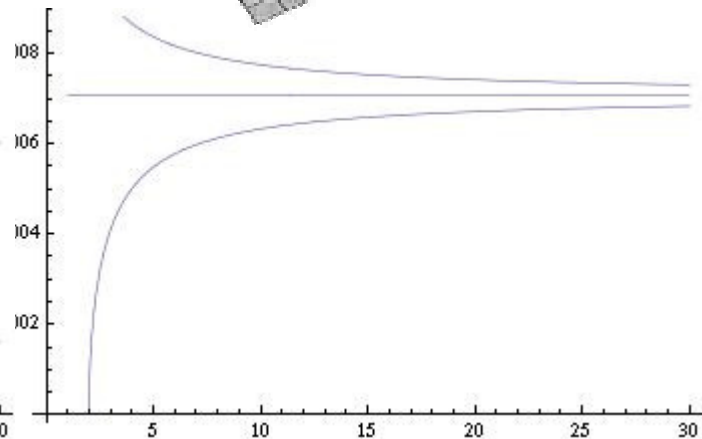
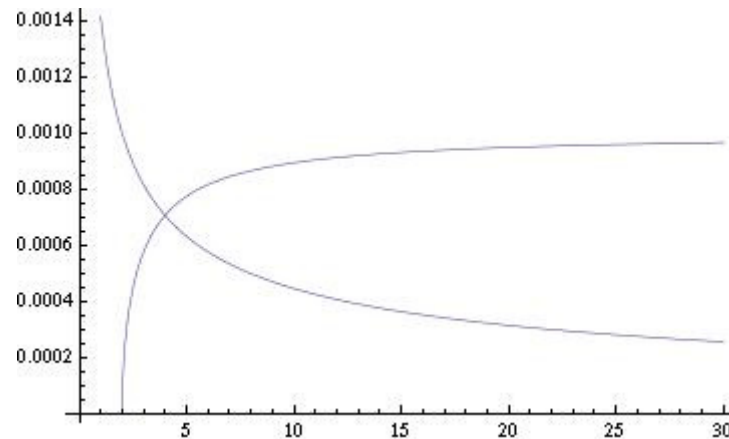
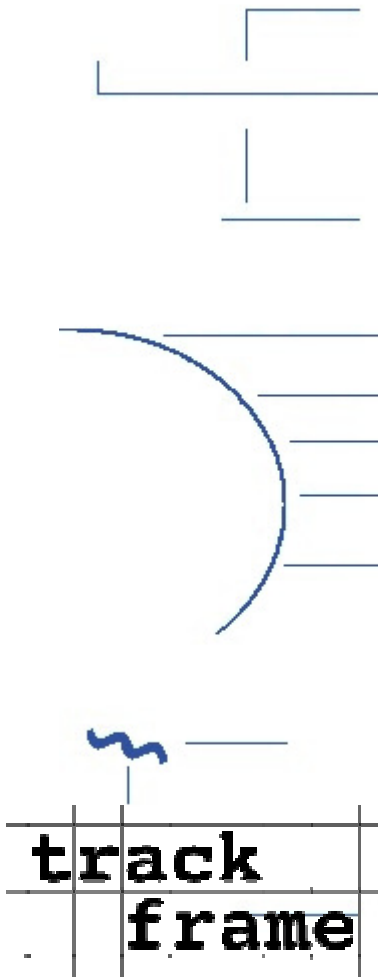
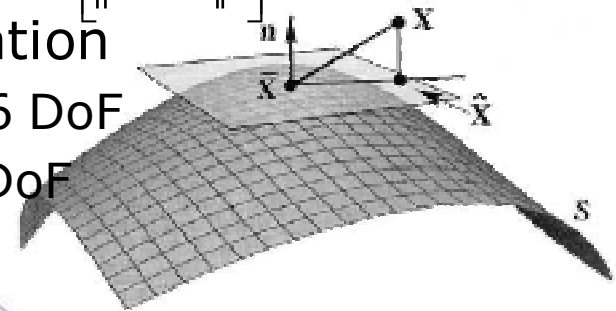

Monte-Carlo Simulation of Alg. Convergence

- Example: 3D-3D pose estimation (according to Horn, using unit quaternions)
- Assumptions:
 - Error in left frame only
 - Isotropic error

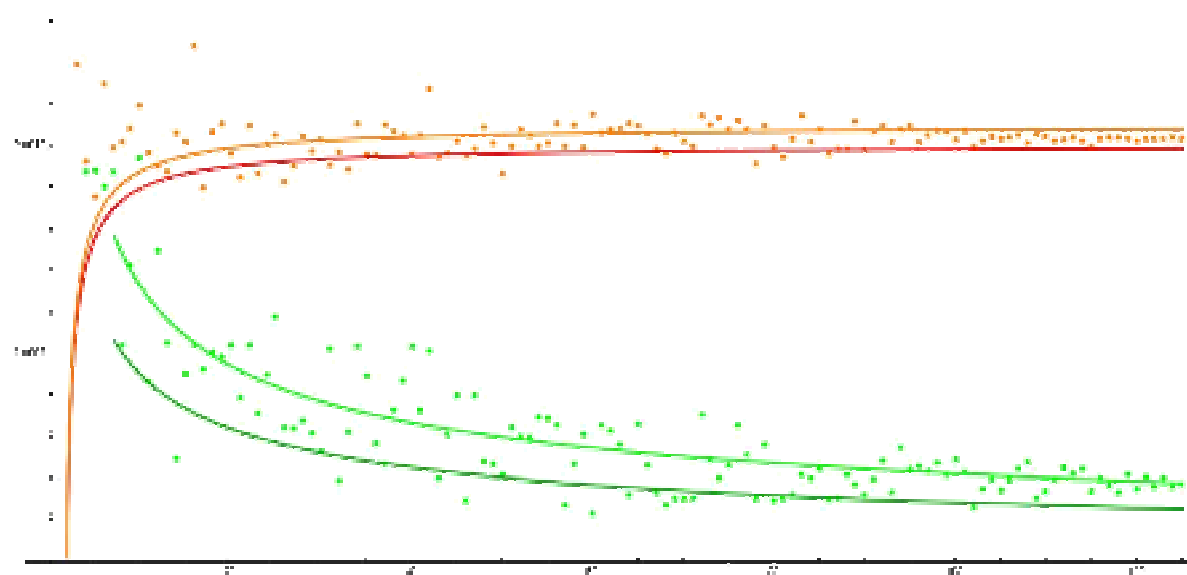
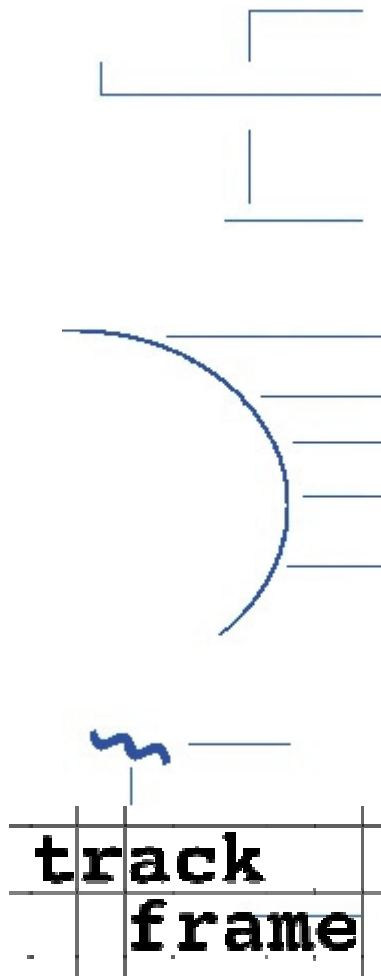

Algorithmic Convergence in trackman

- Example: 3D-3D pose estimation (according to Horn, using unit quaternions)
- Estimate of effective accuracy
- Immediate feedback in case of error

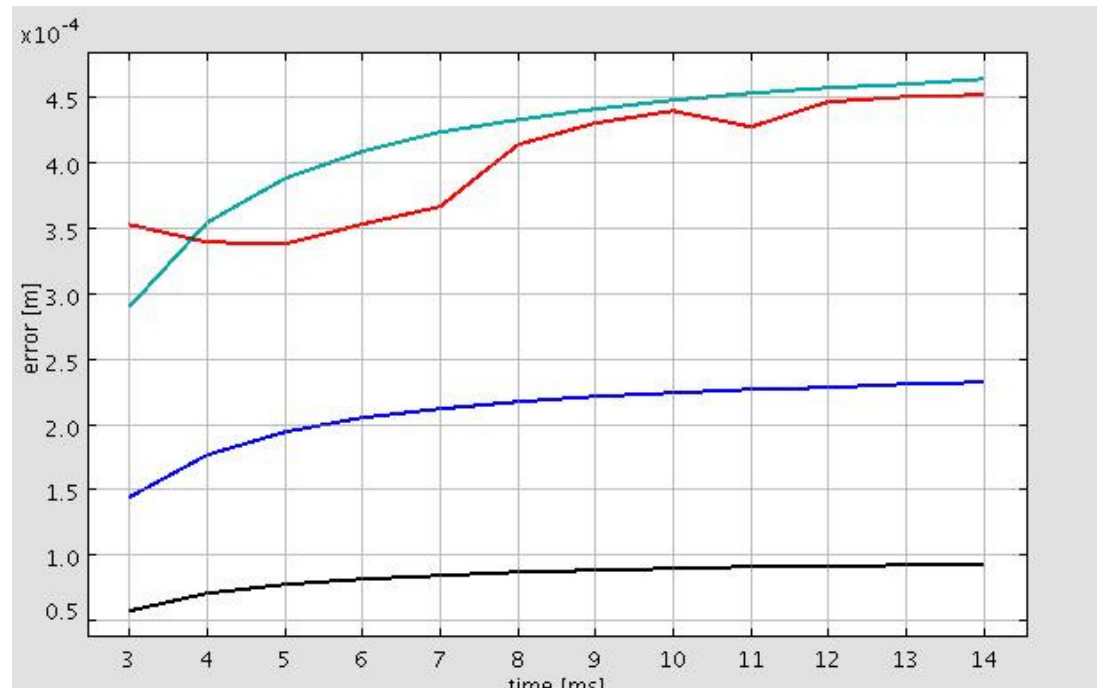
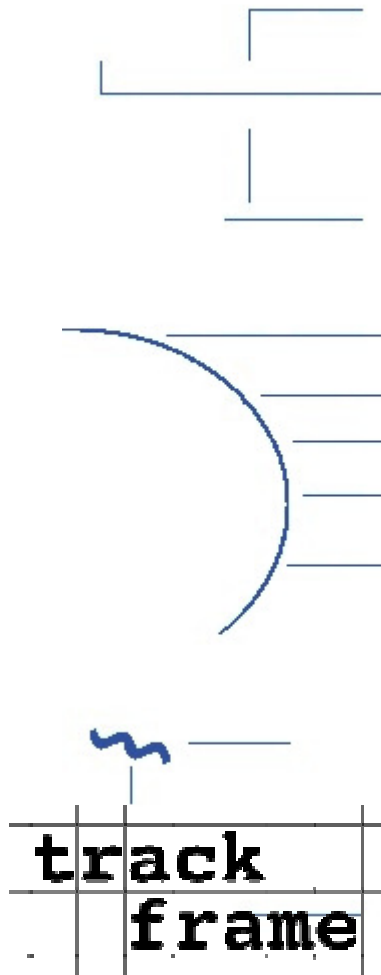

Plausibility Checks

- Idea: Make use of cycles in SRG!
- Comparison of alternative dataflows

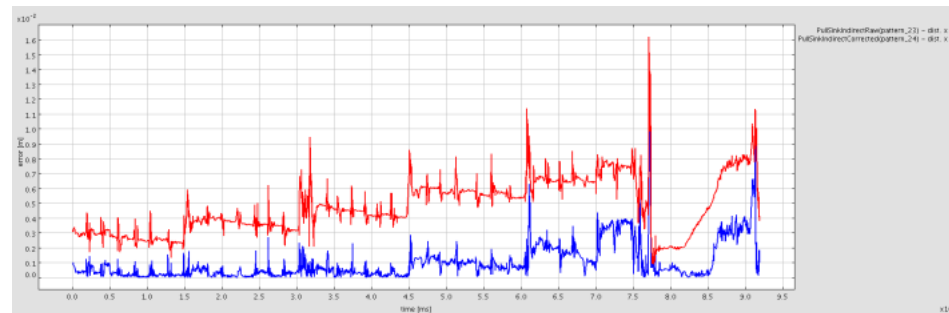
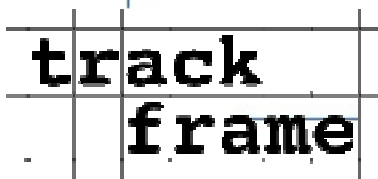
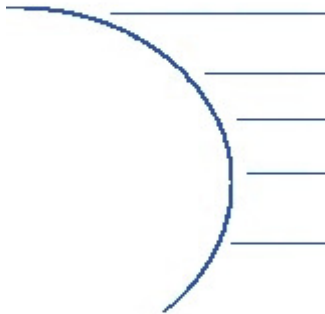
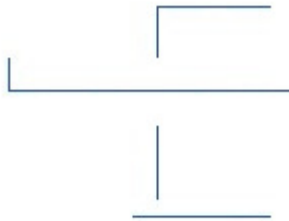

- Meta-Patterns provide simple and generic solutions to most registration problems

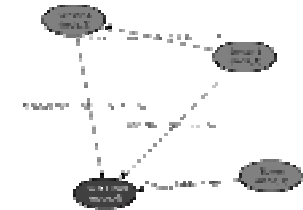

- Monte-Carlo simulation helps to plan new and understand existing tracking environments

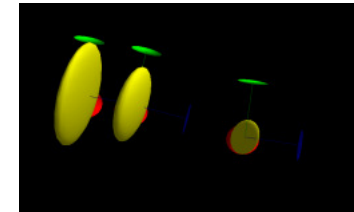

- Tools increase efficiency of registration procedure

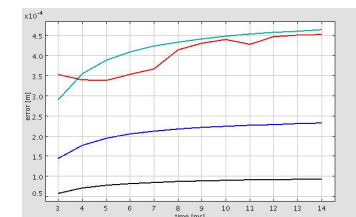

- Use SRG cycles for runtime consistency checks

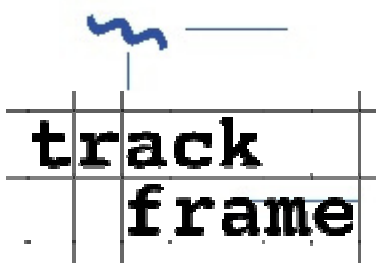
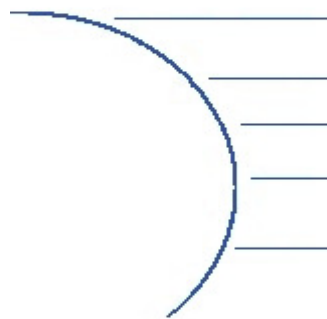
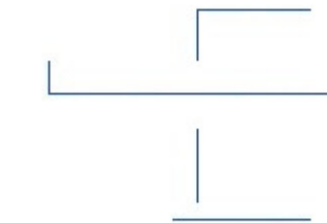
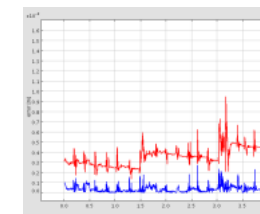

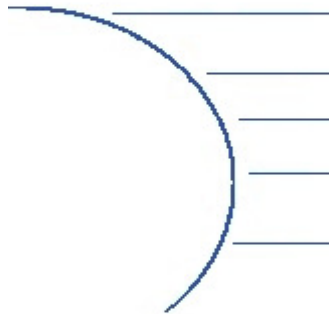
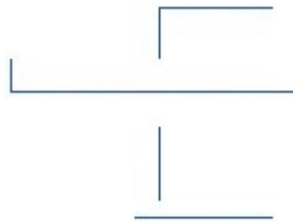

Thank you for your attention.
Questions?

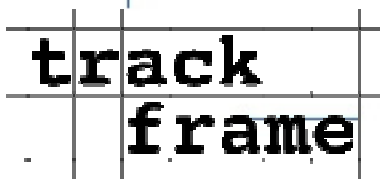

www.trackframe.de